

OCCUPATIONAL HEALTH SOLUTIONS

Volume 14



2	Chairs - Strauss & Crest
3	Chairs - General Seating - Multi-function
4	Chairs - Executive Seating
5	Chairs - Specialty Seating
6	Chairs - Perching, Kneeling, Specialty Seating
7	Seating - Gas Lift Chart
8	Workstations - Eco Desks
9	Workstations - Hire Package
10	Workstations - Gro Retro Sit Stand System
11	Workstations - Gro
12	Support Systems - Forearm & Wrist
13	Support Systems - Footstools, Monitor Lifts & Accessories
14	Support Systems - Monitor Arms & Laptop Holders
15	Support Systems - Copy Holders, Laptop, Notebook & Tablet Stands
16	Keyboard & Mouse - Plus Peripherals
17	Accessories
18	Ergonomics - Health & Safety
19	Ergonomics - Workstation Principles
20	Trial Request System
21	Contact Details



CHAIRS

Strauss & Crest Corporate and VDU Seating



Strauss

3 Lever high back.
CH7014 **\$449**



Crest

3 Lever mid back.
CH7005 **\$399**

Standard Features

- 3 Lever ergonomic multifunction mechanism
- High density moulded foam for long term comfort & support
- Pronounced lumbar support
- Heavy duty gaslift with lifetime warranty
- 10 Year warranty

ADDITIONAL UPGRADES (add amounts as shown)



Adjustable Arms

CH7021 **\$100**



* Draughting option:

Gas lift to standing elevation.
CH7020 **\$164**



Sliding Seat <- 70mm ->.

CH7000A **\$100**

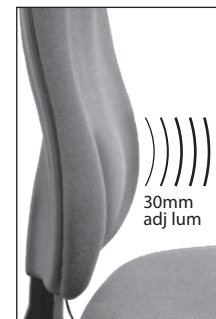

Adjustable Lumbar

<- 30mm ->.
CH7018 **\$100**



Polished Alloy Base

Weight loading over 120kg.
CH7003 **\$100**

Fabric Options:

Leather, Wool, Custom **POA**



CHAIRS

General Seating Multi Function



Ital 2

3 Lever high back.
Also available in mid
back, with or without
arms.

CH7010 High back **\$369**

CH7007 Mid back **\$349**



Plymouth

3 Lever high back.
Low density foam.
Generous proportions.
Rated to 180kg

CH7001
Without arms **\$489**

CH7002
With adjustable arms **\$589**



Otto

3 Lever mid to high back.

CH7015
Mid to high back **\$298**

CH7015A
With adjustable arms **\$398**



Spectrum

3 Lever high back.

CH4203 High back **\$449**

CH4200
With adjustable arms **\$549**



CHAIRS

Executive Seating



ES Air

Includes:

- Adjustable arms (removeable)
- Sliding seat
- Adjustable lumbar support
- Weight tilt adjustment
- Chrome Base and gas lift
- P.U. Leather (Black or white)

COMPUTER GUIDELINES

"Furniture should be designed to make the user move"...



ES Air

CH7038 Black \$699
CH7038A White \$699



CHAIRS

Specialty Seating

Tech Stool

The Boomerang arm and Stool offer maximum versatility via multiple adjustment ranges.

The Tech stool has a height range of 550 - 730mm, measured from the floor to the base of the seat.

Other height ranges can be achieved by altering the gas lift.

The swing-round backrest can be rotated 360 degrees around the seat. It includes a ratchet system which allows the backrest to be moved across the seat, enabling the user to use it as a forward rest as well.

This arm can be retro fitted to most existing seating.



CH9928 Arm **\$249**
CH4005 Stool **\$199**
CH7020 Ring & Gas **\$164**

CH4028C
Complete as pictured \$612



The arm is also height adjustable independently from the stool.



Mobile Leg Rest

Height adjustable 400 – 460mm.

CH9927 **\$249**



Adjustable Lumbar Support

With cover and strap - compatible for wheelchair & office seating.

Self inflatable with valve adjustment.

CH2903 **\$138**



Bambach Saddle Seat

CH4001 **\$899**

CH4002 With back **\$1,159**



CHAIRS

*Perching, Kneeling,
Specialty Seating*



Perching Stool
No Longer Available



**Posturite
Perching Stool**
With seat tilt and glides.
265mm Gas
CH4004 **\$385**



**Muv Man
(and Woman) Flexi
Perching Stool**
Flexible - designed to encourage
user to MOVE. Sitting heights
from 510mm - 840mm.
Sit, Stand, Perch, Move, with Non-
slip base and carry handle.
CH9926 **\$799**



Kneeling Chair
Gas height adjustable.
CH4007 **\$329**



Standard Tech Stool
Round top. Ring lift - non
orientation.
CH4005 **\$199**



Ergo Saddle Seat
CH4001A **\$399**



SEATING Gas Lift Chart

Chair Gas Lift Chart

- Low 100mm stroke 370 - 460mm
- Std 140mm stroke 405 - 530mm
- Mid 200mm stroke 470 - 645mm
- High 265mm stroke 590 - 810mm
- SS Sliding seat adds 20mm height

NOTE:
DIMENSIONS ABOVE ARE FROM FLOOR
TO SEAT PAN HEIGHT

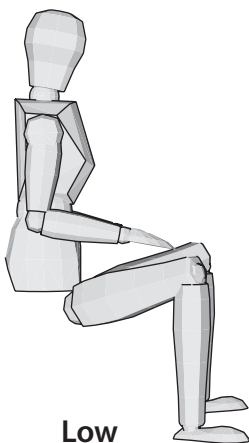

Low

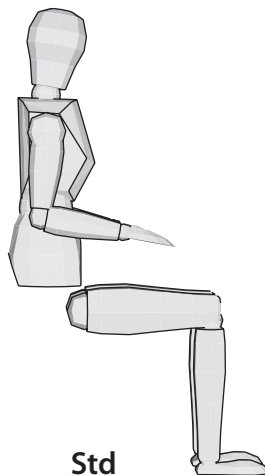

Std

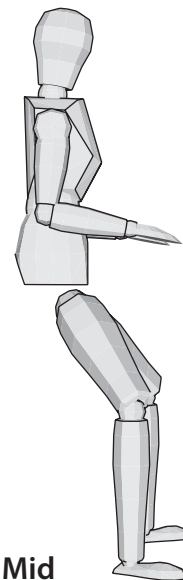

Mid

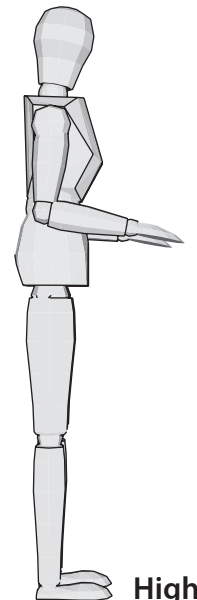

High



WORKSTATIONS

ECO Desks

Eco Height Adjustable Desks

Desk top items shown not included



1700 x 1700mm WS2208 **\$799**
Drawer unit extra

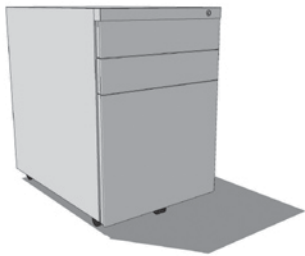

Mobile 3 Drawer

563mm H x 395mm W x 545mm D.
Goes alongside or underneath.
ST2200E **\$249**



Left & Right Return
1700 x 1200mm WS2200 **\$599**

- Simple assembly
- ECO height adjustable screw leg
- Functional reach envelope
- Suitable for CRT and LCD screens
- Optional contract installation (extra)
- Pre-mounted pintles for ease of assembly
- Adjustable height as recommended by computer guidelines

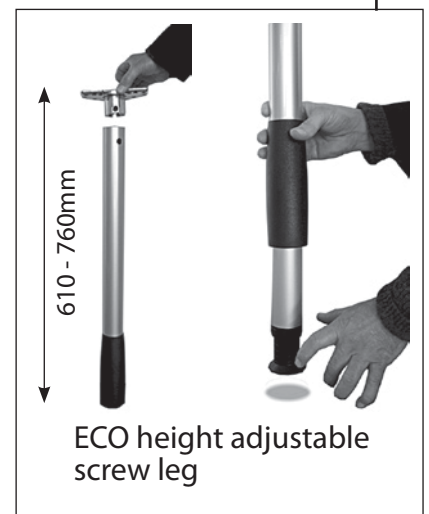
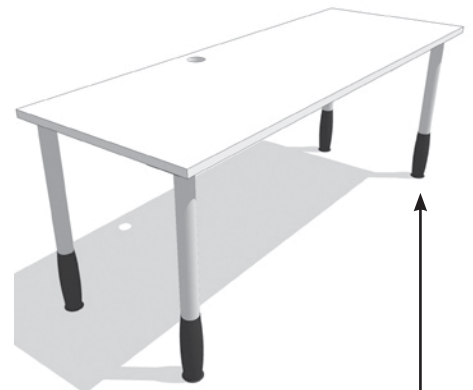

ECO height adjustable screw leg

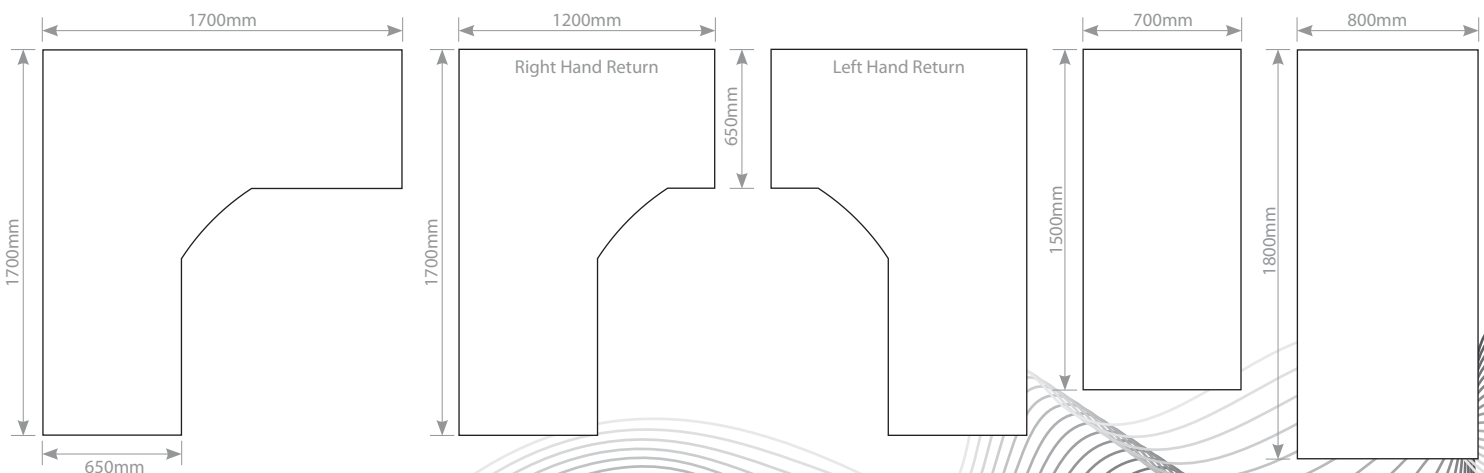



WORKSTATIONS Hire Package

Ergostyle Hire Package Minimum hire period: 6 Weeks

Includes:

- Desk - height adjustable with a choice of shapes
- Mobile drawer set
- Chair
- Copy holder - A3
- Adjustable monitor stand
- Adjustable foot rest

From \$49 per week plus delivery and installation.

These and other individual items available for hire on request.

Ideal for:

- Job training
- Rehabilitation
- Work trials
- Short term work placement
- Residual purchase option available at end of hire period



ECO 1700 x 1200mm height adjustable

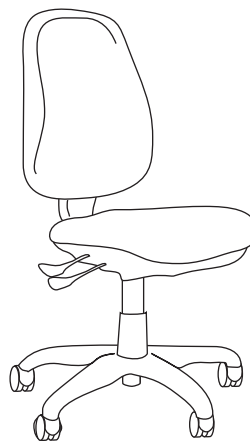

3 lever Chair

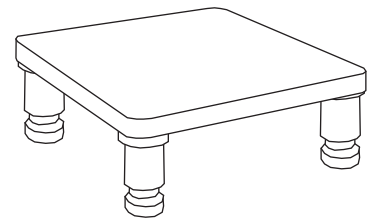

EMS Monitor Stand

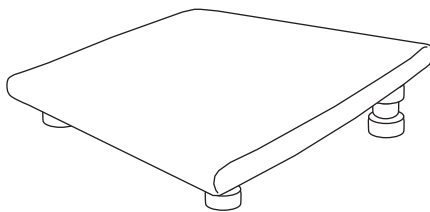

EFS Easy Footstool

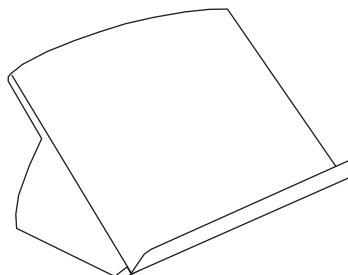

EDH Easy Document Holder A3



MOB3 Mobile 3 drawer



WORKSTATIONS

GRO Retro Sit Stand System

GRO Retro Sit – Stand
WT2209 \$990

Single hand wheel facilitates fitting of the GRO Retro to existing workstation allowing the user to sit or stand.

Height range 580 -1050mm (based on mounting to a 700mm high existing workstation).

Independent height & pitch adjustment for screen.

Easy assembly with standard vesa screen mount.

Slide out tray for ambidextrous mouse position.

Tension adjustment for finger tip control.

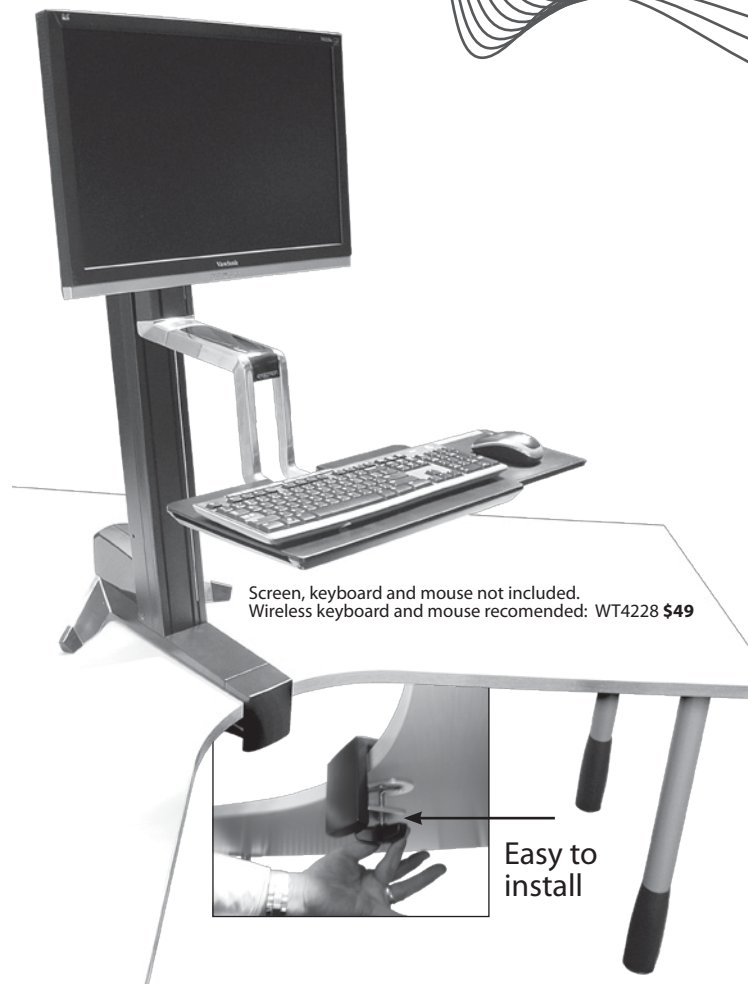

Screen, keyboard and mouse not included.
Wireless keyboard and mouse recommended: WT4228 \$49

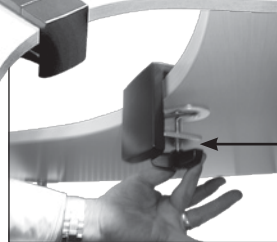

Easy to install

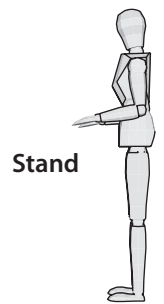

Stand

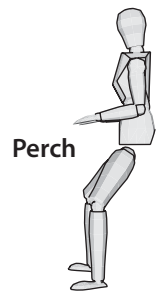

Perch

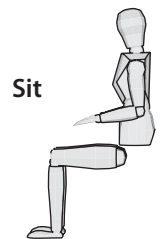

Sit



Gro Retro Laptop Holder
WT2210 \$99

Dual Screen Option available
WT2211 \$1,060





WORKSTATIONS GRO

GRO Linak Electric Height Adjustable Workstation

WS2201 1800 x 1800 x 700mm - corner **\$3,250**
 WS2204 1800 x 800mm - clerical **\$2,650**
 Other sizes available on request.

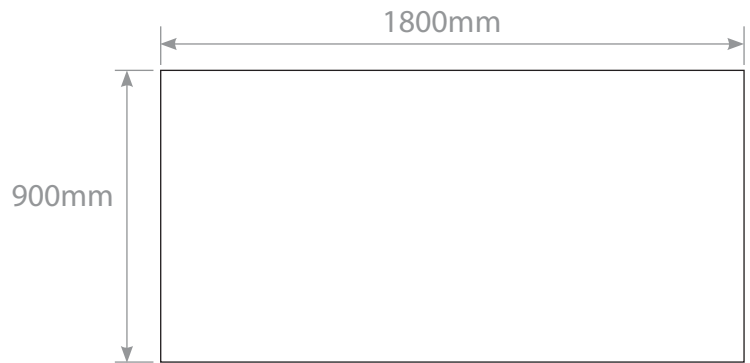

WS2204

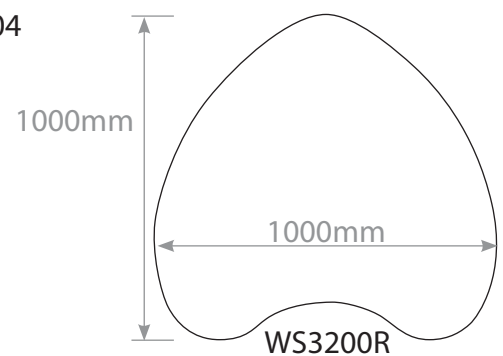

WS3200R

GRO Regular Electric Height Adjustable Workstation

WS2201R 1800 x 1800 x 700mm - corner **\$1,729**
 WS2204R 1800 x 800mm - clerical **\$1,145**
 WS3200R 1000 x 1000mm - heart shape **\$1,229**
 Other sizes available on request.

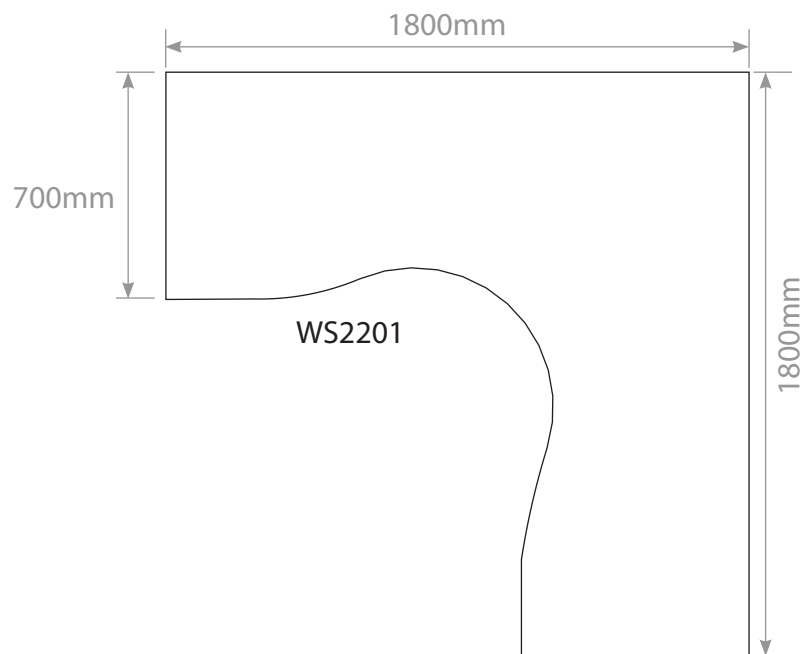

WS2201

GRO Workstation Features

- Linak adjustment range 650 - 1320mm
- Regular adjustment range 685 - 1205mm
- Linak is Heavy duty with many extra features
- Regular is the Economy Option
- 70kg Lift Capacity
- Wheelchair compliant
- 5 Year warranty

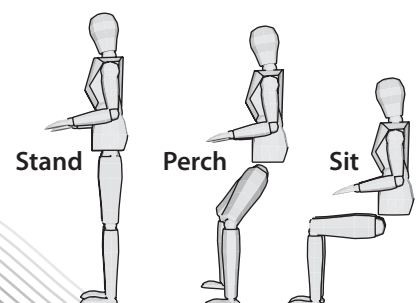



SUPPORT SYSTEMS

Forearm & Wrist

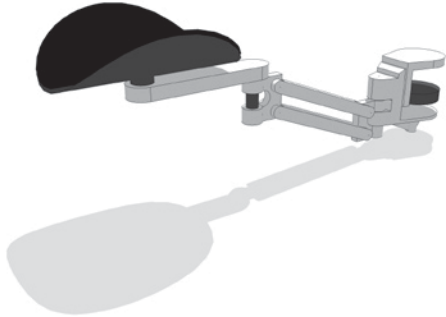

Ergo Rest
WT7002 \$219

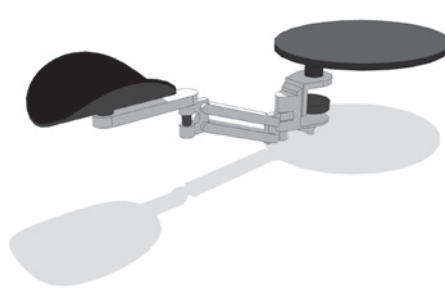

Ergo Rest with Mouse Support
Wide mount jaw, longer post and longer pad available.
WT7005 \$299

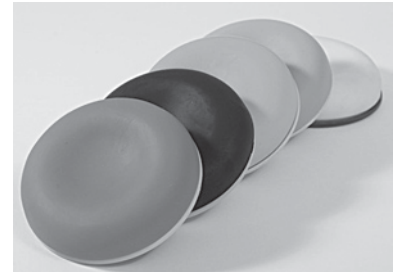

PUK Wrist Support
Gadget candy that brightens the desk top. Mouse wrist support. Used correctly, helps reduce wrist extension & deviation. Top = Thermoplastic Elastomer (No latex). Base = DuPont development compound, low friction.
WT7010 \$29



Natural Keyboard Wrist Support
WT2308 \$59



Gel Keyboard Wrist Support
Leatherette.
WT7011 \$45



SUPPORT SYSTEMS

Footstools, Monitor Lifts & Accessories

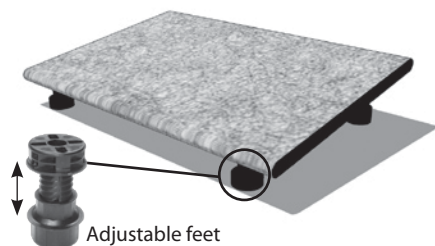

Easy Footstool

WT2021 \$69



Footstool High (Tellers)

Height adjustable 200 - 330mm.
WT2042 \$139



Wilson Footstool

WT4229 \$99

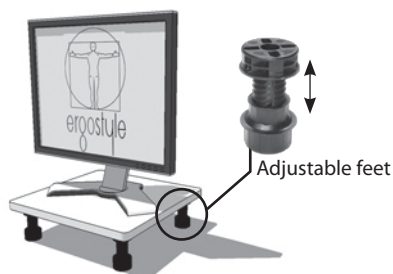

Easy Monitor Stand

Black, 350mm square, height adjustable 30 - 130mm. Please enquire for other colour options.

WT2032 \$69



Keyboard Garage

Height adjustable 30 - 130mm.
WT4238 \$119



Desk Bridge

30mm I.D. Satin Black. To enhance a 90 degree corner to a more serviceable area.

WT6600 \$59

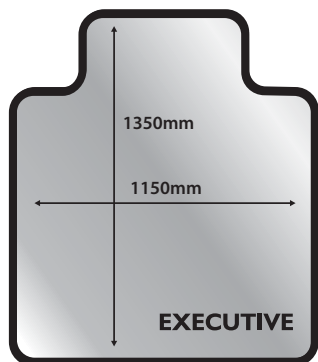

Executive Chair Mat

SC3005 \$145

Anti Fatigue Mat

Per metre - 900mm wide.

SC3001 \$169

Multizone Mat

915mm square, interlocking.

SC3006 \$79



Standing Work Surface

Desk Top

300 - 420mm Height and pitch adjustable.

Boomerang Top 1030 x 430mm.

WT5005 \$399

Rectangle Top 650 x 500mm.

WT5005A \$399



SUPPORT SYSTEMS

Monitor Arms and Laptop Holders



Evo LCD Monitor Arm

Unique features include a clever quick-install mechanism which allows monitors to quickly and securely snap into position; a desk clamp mount which can be reconfigured for thru-desk mounting; and integrated cable management to reduce workspace clutter.

Effortless hand control for optimum positioning.

WT6604 **\$452**



Evo Notebook Holder

Add a notebook holder. Expandable to fit most sizes.

NOTE:

Monitor Arm not included requires EVO 5545 LCD Arm

WT6606 **\$119**



Pro Motion Arm

Pro Motion uses a Geometric Spring System (GSS) to provide the greatest range of articulation of all 'dynamic' monitor arms and a movement that is the smoothest and lightest available for easy screen adjustability.

WT6621 **\$299**

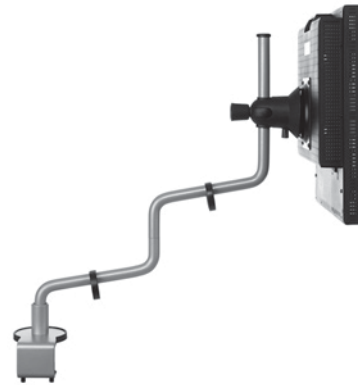

Rodney LCD Monitor Arm

This 'all in one box' solution includes a desk clamp and cable management facility with no need for a separate arm and post. Rodney is also environmentally friendly, using less material and packaging.

WT6622 **\$199**



SUPPORT SYSTEMS

Copy Holders, Laptop, Notebook and Tablet Stands

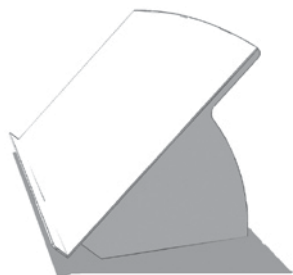

Easy Document Holder A3

WT2010 \$99

Magnetic Curser

WT4240 \$20



Superlux Desk A4

WT4233 \$55

Superlux Desk A3

WT4232 \$65



MicroDesk Acrylic

Height and pitch adjustable.

WT4220 \$149

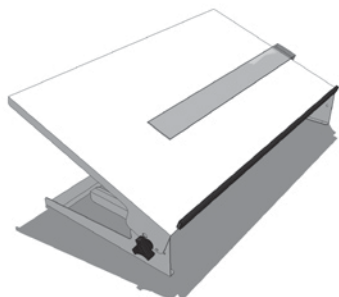

SeeWrite

Height and pitch adjustable.

WT4239B \$160



Computer components shown not included

Cricket Portable Notebook Stand

Recommended for use with laptops, notebooks and tablets.

WT6610 \$99



Easy Notebook Stand HUD

30° pitch. WT8001/30 \$149



Easy Notebook Stand HUD

45° pitch. WT8001/45 \$149



Logitech Wireless Keyboard & Mouse Combo

Recommended for use with
laptops, notebooks and tablets.

WT4228 \$49



KEYBOARD & MOUSE

Plus Peripherals



Microsoft Multimedia Natural Keyboard
WT6237 \$125



Gold Touch Adjustable Keyboard
WT6248 \$345



Evo Lefthand USB Keyboard
WT6241 \$180



Laptop Style Keyboard with Touch Pad
WT6239 \$139
2/3rds Mini USB Keyboard
WT6239A \$89

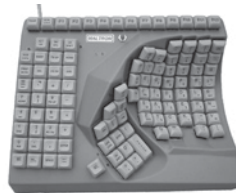

Maltron Keyboard Left or Right Hand
WT6240A \$1,387



Logitech Wireless N305 Wireless Keypad
WT2301 \$59



Vertical Mouse - Right Hand only
Large WT2101 \$139
Small/Medium WT2102 \$139
Wireless
Large WT2105 \$179
Small/Medium WT2106 \$179



EVO Vertical Mouse
Left or Right Hand. Small to Large
Right hand WT6002 \$219
Left hand WT6006 \$219
Wireless
Right hand WT6002W \$249



Switch Mouse
Ambidextrous, adjustable length.
WT8027 \$189



ACCESSORIES



Plantronics DuoSet Mono Aural Headset

Overhead, left or right ear hook.
WT2012 Curly Cord if required.
WT2019 **\$149**
WT2012 **\$33**



Plantronics Amplifier

WT2025 **\$199**



Economy Phone & Headset

WT2225 **\$299**



Desk Clamp Shelf

580 x 290mm, 3 Hoops.
Other sizes as pictured available.
ST2012 **\$149**



Wireless Addcom Headset

Complete with lifter.
WT8034A **\$399**

Addcom Lifter

WT8034B **\$130**



Ergostyle Desk Elevator

25mm Blocks that interconnect
with each other to provide
a simple solution for raising
workstations.
CP2006 **\$9.90ea**

ERGONOMICS

HEALTH & SAFETY

The core ideals surrounding the 2interface.com range of products are firmly entrenched in basic ergonomic principles. Fundamentally, these revolve around the concept of the human centred design and fitting the task to the person.

These principles are reinforced by Health & Safety in Employment legislation and the legal obligation of employers to shield their staff from risk of injury.

What is not widely recognised is the alarming increase in computer operators experiencing discomfort as the result of non compliant workstations and poor work habits.

Recommended reading:

Guidelines to using Computers

Preventing and managing discomfort, pain and injury.

www.osh.dol.govt.nz

Human-Machine System

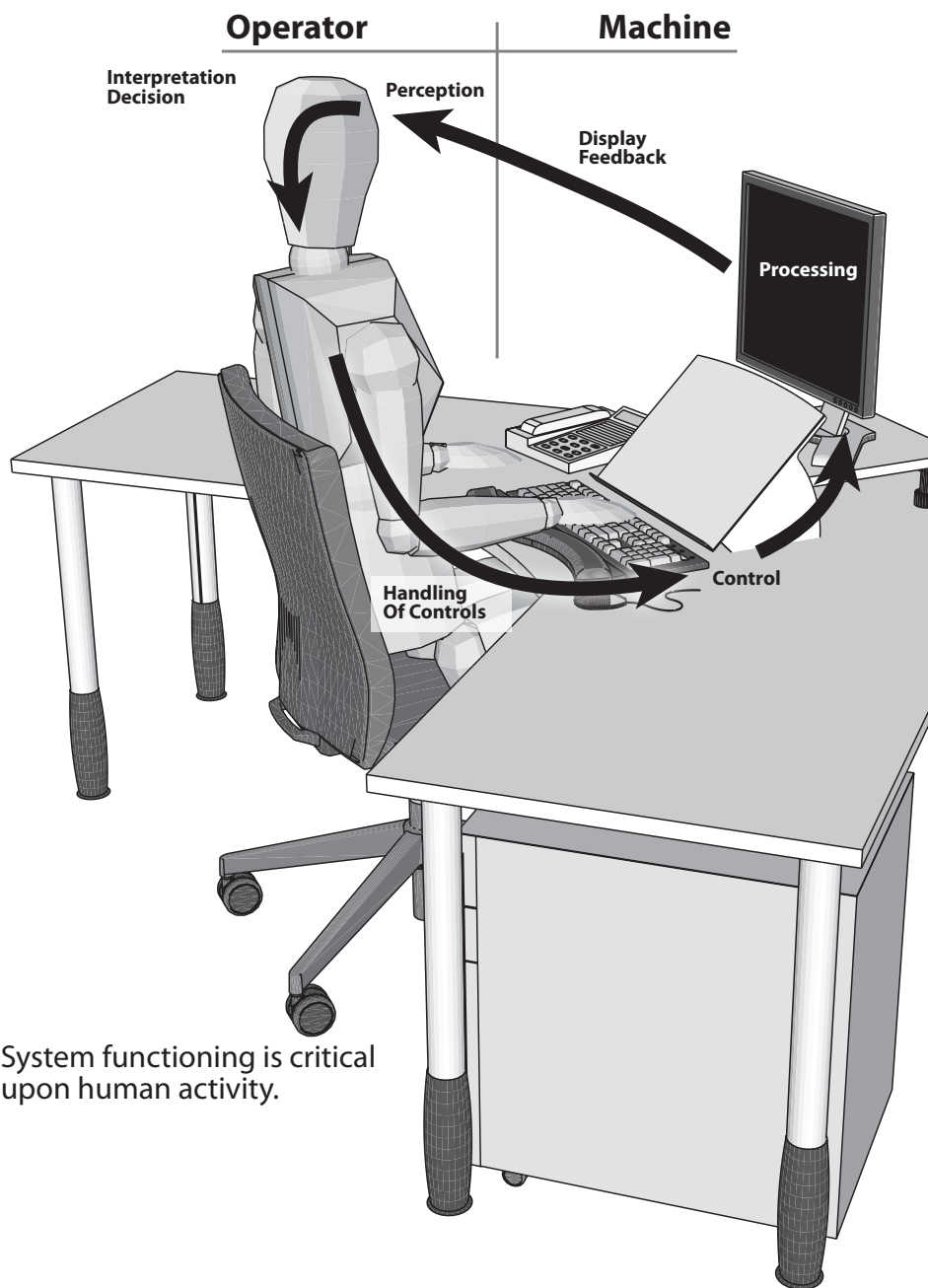

System functioning is critical upon human activity.

WORKSTATION PRINCIPLES

Set up your workstation to allow easy access to primary tools and resources, avoiding unusual body postures. Sounds simple and logical...but is not very commonly followed.

Identify primary tools and resources (i.e. things you would use at least once an hour)

- Keyboard
- Mouse
- Phone
- Working files, documents
- In / out trays

Primary tools and resources should be positioned within the reach envelope. All documents should be placed onto the document holder when working with them.

Micro pause, 10 seconds every 3 - 5 minutes.
Rest break once an hour (get out of your chair).

Identify secondary tools and resources (i.e. things you would use once a day).

- Phone books
- Printer
- Hard drive
- Resource folders
- CD drive
- Calculator

Identify other tools and resources (i.e. things you would share in a work group).

- Scanner
- Fax machine
- Central printer
- Photocopier
- Filing cabinets
- Stationery

Secondary and other tools should not encroach the reach envelope.

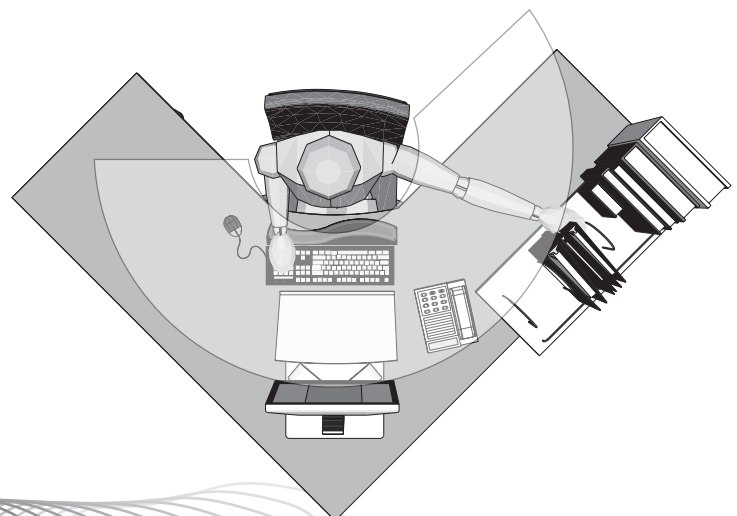
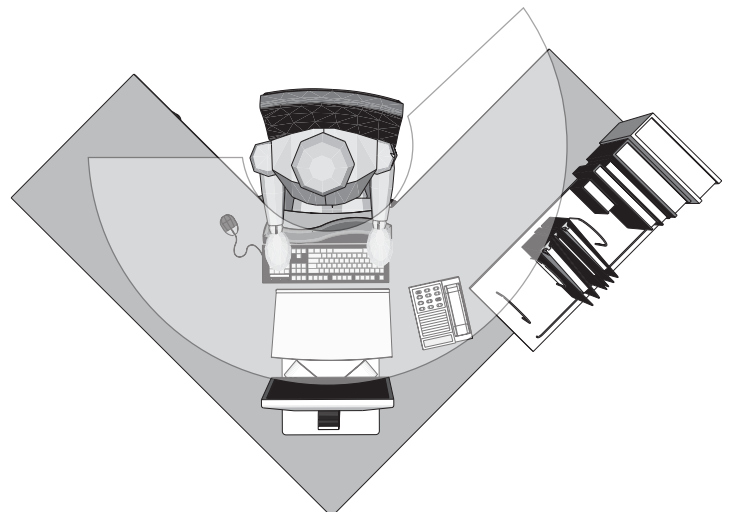

TRIAL REQUEST SYSTEM

In the interests of establishing suitability and proving an outcome, Ergostyle is happy to arrange a user trial of our products in most circumstances.

New product is used in most cases & where possible end user training is provided at time of installation. Whilst this is a free service, a freight cost contribution may be sought in the event of an unsuccessful trial.

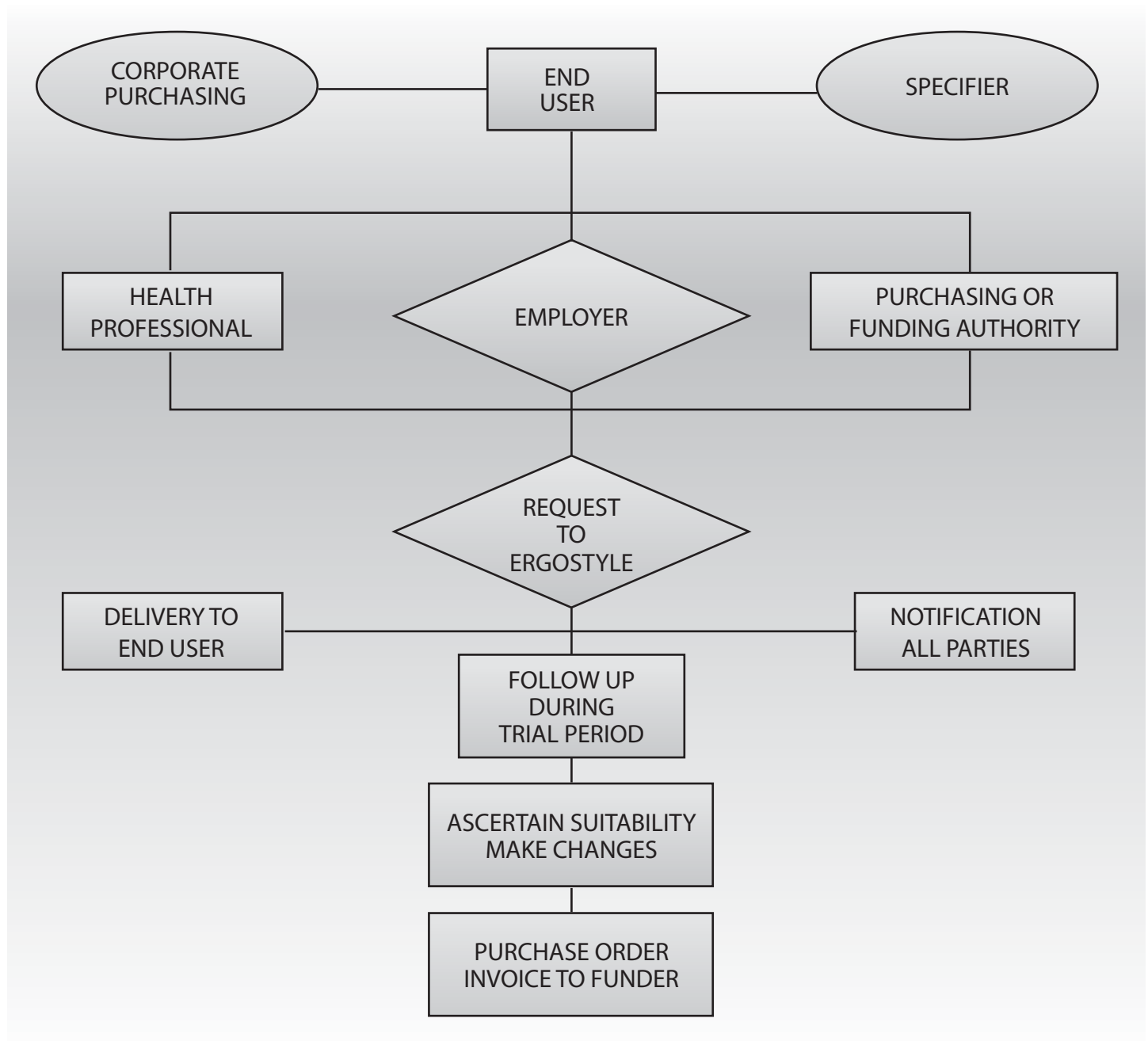

CONTACT DETAILS



Nic Purcell
Ergonomist
027 534 3174
nic@ergostyle.co.nz



Clinton Selby
Director / Projects
027 488 8223
clinton@ergostyle.co.nz



Gillian Kitchen
Office Manager
0800 378 953
gillian@ergostyle.co.nz

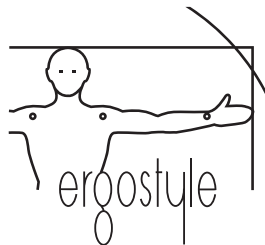

Ergostyle
Auckland + Christchurch
P: (03) 366 8810
F: (03) 366 8817
E: info@ergostyle.co.nz
W: www.ergostyle.co.nz
Free Phone: 0800 378 953

- Occupational health and disability solution providers
- Designers and creators of contemporary ergonomic equipment
- Consultation and design for optimized corporate and commercial workspaces
- Ergonomics education and training providers
- Importers and distributors of high quality ergonomic furniture and accessories
- Co-ordination service for architects and designers

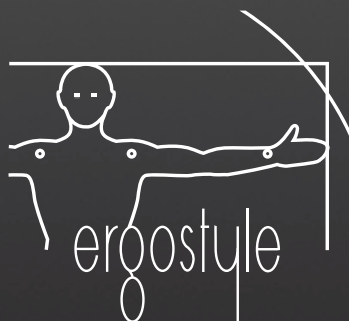

Auckland + Christchurch, New Zealand
Tel +64 03 366 8810
0800 e style (0800 378 953)
Email: info@ergostyle.co.nz
www.ergostyle.co.nz