

KEYSTONE™

recipe book

A multi-purpose, modular
furniture system for today's
rapidly-changing workplace

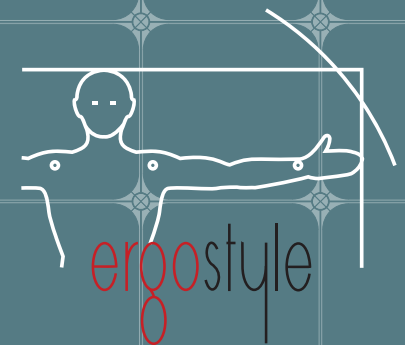



www.iqcommercial.co.nz

We've been
cooking up
something
special...

In today's rapidly changing workplace what works as an office layout today may not work tomorrow.

As an investment, office furniture should be flexible, agile and consider the future.



Enter KEYSTONE™

A new modular furniture system
from IQ Commercial.

Building on IQ Commercial's successful
series of acoustic pods, Keystone™ is
another step forward in modular furniture
due to its innovative, reconfigurable design.

As its name suggests, Keystone™ offers
you a central, foundational system which
provides support for the entire office.

Have your cake and eat it too.

Change is a guaranteed part of the modern workplace.

Whether due to team growth, large-scale organisational restructure or changes to accommodate new styles of working, furniture should be flexible, agile and consider the future.

A KIT OF PARTS

Keystone™'s unique modular design provides modern office users superior flexibility and agility. It offers users a "kit of parts" - an inventory of interchangeable components or "ingredients" which can be combined and reconfigured into various "recipes"- adapting to evolving needs with minimal investment.

Customise your furniture by choosing and assembling elements into unique combinations which work for your own staff and floor plan.

À LA CARTE

Each piece can be bought, shipped and stored individually depending on the requirements of an office at a particular point in time.

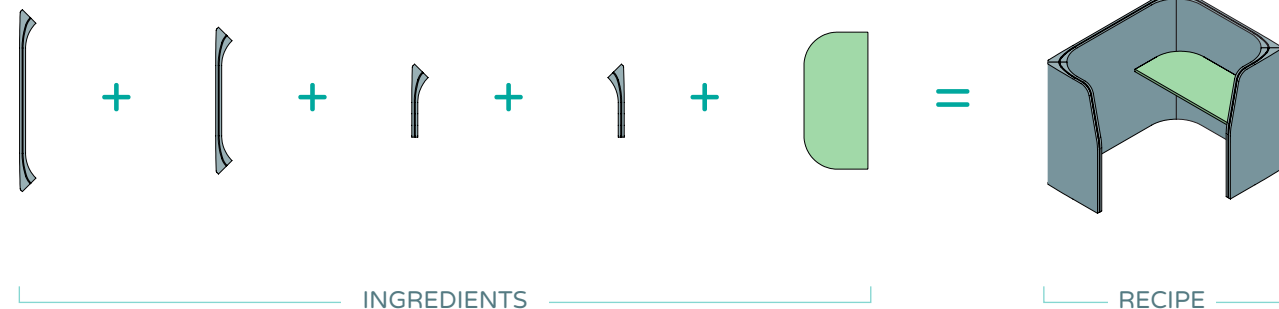

Modular: Interchangeable "ingredients" combine to form custom "recipes."

MULTI-FUNCTIONAL

Traditional office furniture can be limiting. A single item of furniture is used for a single purpose. With Keystone™, however, a focus pod can be reconfigured to be a sofa or a collaborative setting offering a unique, multi-functional user experience.

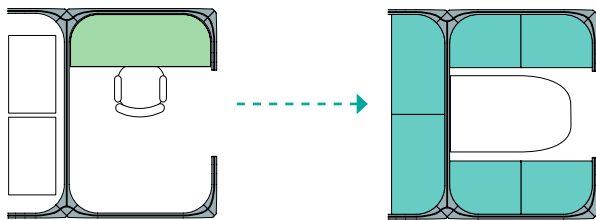

FOCUS POD

MEETING SPACE

Reconfigurable: Add and remove parts to create different solutions according to user requirements.

FUTURE-PROOF

Due to its inherent modular design, Keystone is scalable, allowing users the ability to future proof offices without setting the arrangements in stone. This offers users the ability to scale up and down with shifts in staff or changes to office space or location.

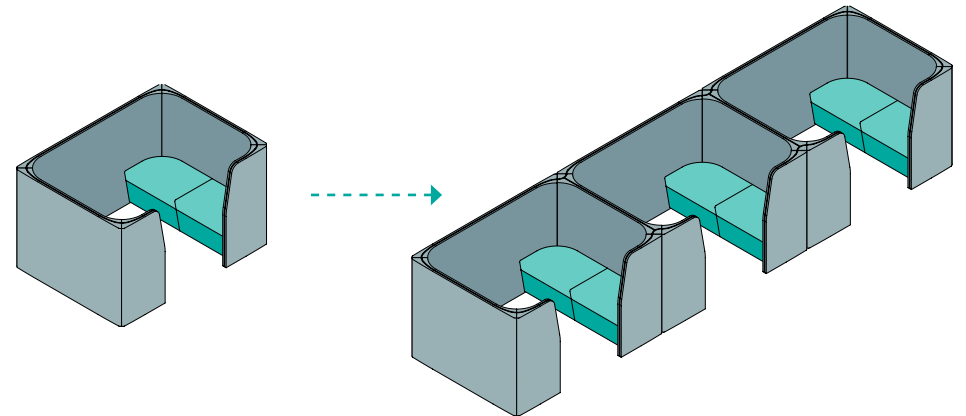

Scalable: Add and remove parts to create different solutions according to user requirements

Hungry for change.

Supporting the latest ways of working.

In our quest to improve productivity and well-being within the modern workplace, IQ Commercial seeks to integrate new technologies into our furniture designs, improve efficiencies and support the latest ways of working.

COLLABORATION VS FOCUS

Furniture solutions should enable workers to be more productive within their working environment - which means striking a balance between promoting collaboration and allowing essential quiet spaces.

Keystone allows for a variety of layouts to be assembled from the same ingredients - covering all the bases.

Focus pods create areas to be used by staff who want quiet spaces. Collaborative meeting spaces with soft seating allows for spontaneous catchups in ways that do not disrupt those involved in concentrated work. Connected pods in rows creates alternative desk space for more mobile users or temporary team members.

The system has been detailed to allow for the full integration of power/data, cable management and technology, ensuring seamless user experiences and supporting workplace productivity and flexibility.

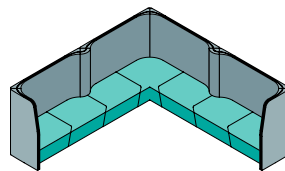

COLLABORATION

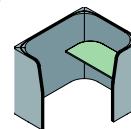

FOCUS

Balance of focus vs collaborative space



This really takes the cake

A quiet spot to work is now one of the most sought-after features in an open plan office.

Stress, fatigue and loss of cognitive ability due to noise and distraction is on the rise. Investing in high-quality, soft furnishings helps mitigate the impact of noise and collaborative efforts.

NOISE AND ACOUSTICS

IQ Commercial's soft furniture has been specifically designed using thousands of layers of Phonix™ nanofibre in a proprietary composite. The microscopic fibres create an incredibly thin, dense web which drastically improves sound absorption levels across a broad range of frequencies.

This world-leading application of nanofibre (with proven noise reduction properties) results in superior, measurable acoustic performance and creates opportunities for new ways of working.

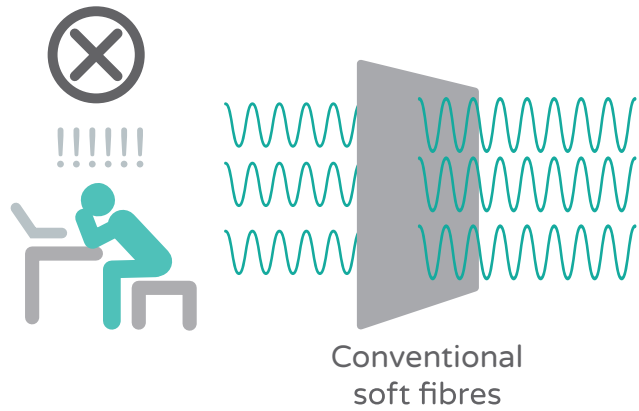

CONVENTIONAL
SOFT FURNISHINGS

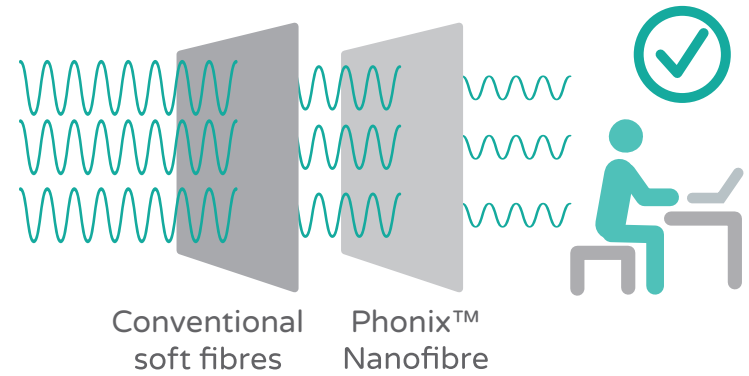
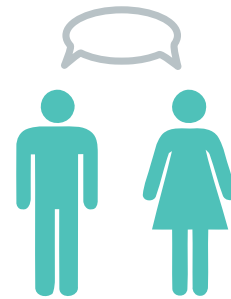

KEYSTONE

Everything but the kitchen sink.

EASY AS PIE

Here's how it works. Keystone offers you a choice of "ingredients" which fit together to create "recipes". The shared wall system reduces the number of parts required and recipes are reconfigurable depending on your needs.

INGREDIENTS

WALLS

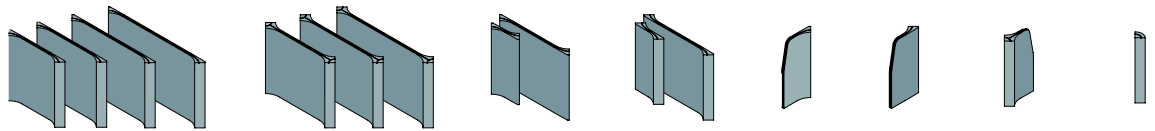

KSW-01

KSW-02

KSW-03

KSW-04

KSW-07

KSW-08

KSW-09

KSW-10

DESKS

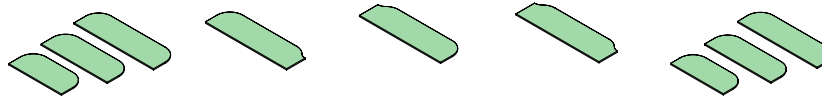

KST-01

KST-02

KST-03

KST-04

KST-05

SEATS

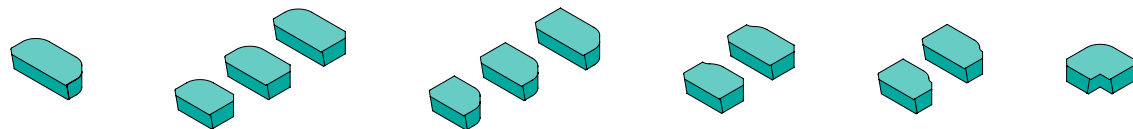

KSS-01

KSS-02

KSS-03

KSS-04

KSS-05

KSS-06

RECIPES

TABLE FOR ONE

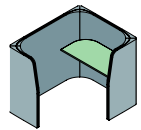

1 user

PRIVATE DINER FOR TWO

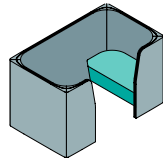

2 users

PRIVATE DINER FOR FOUR

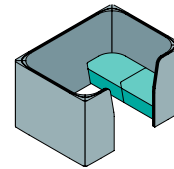

2-4 users

PRIVATE DINER FOR FOUR - PLUS

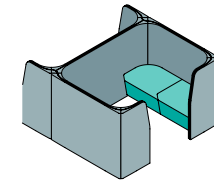

4-6 users

DeguSTATION - TASK

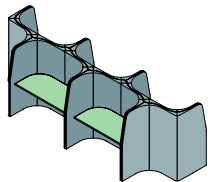

5 users

DeguSTATION - LOUNGE

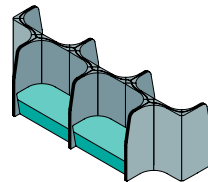

5-10 users

BANQUET - CORNER

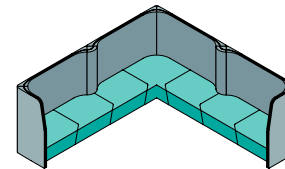

4-6 users

BANQUET - PLUS

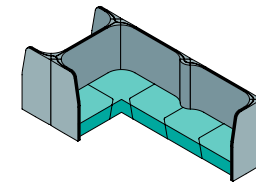

4-6 users

PETIT FOUR

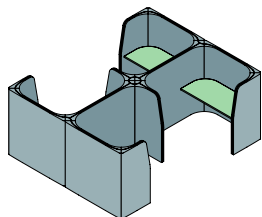

4 users

PICNIC TABLE

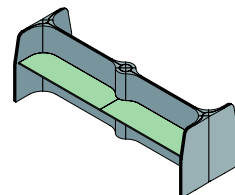

4-8 users

PICNIC BENCH

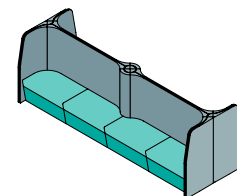

4-8 users

SLICE

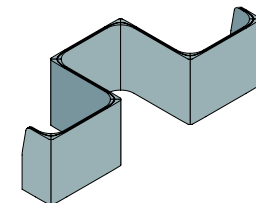

TABLE FOR ONE

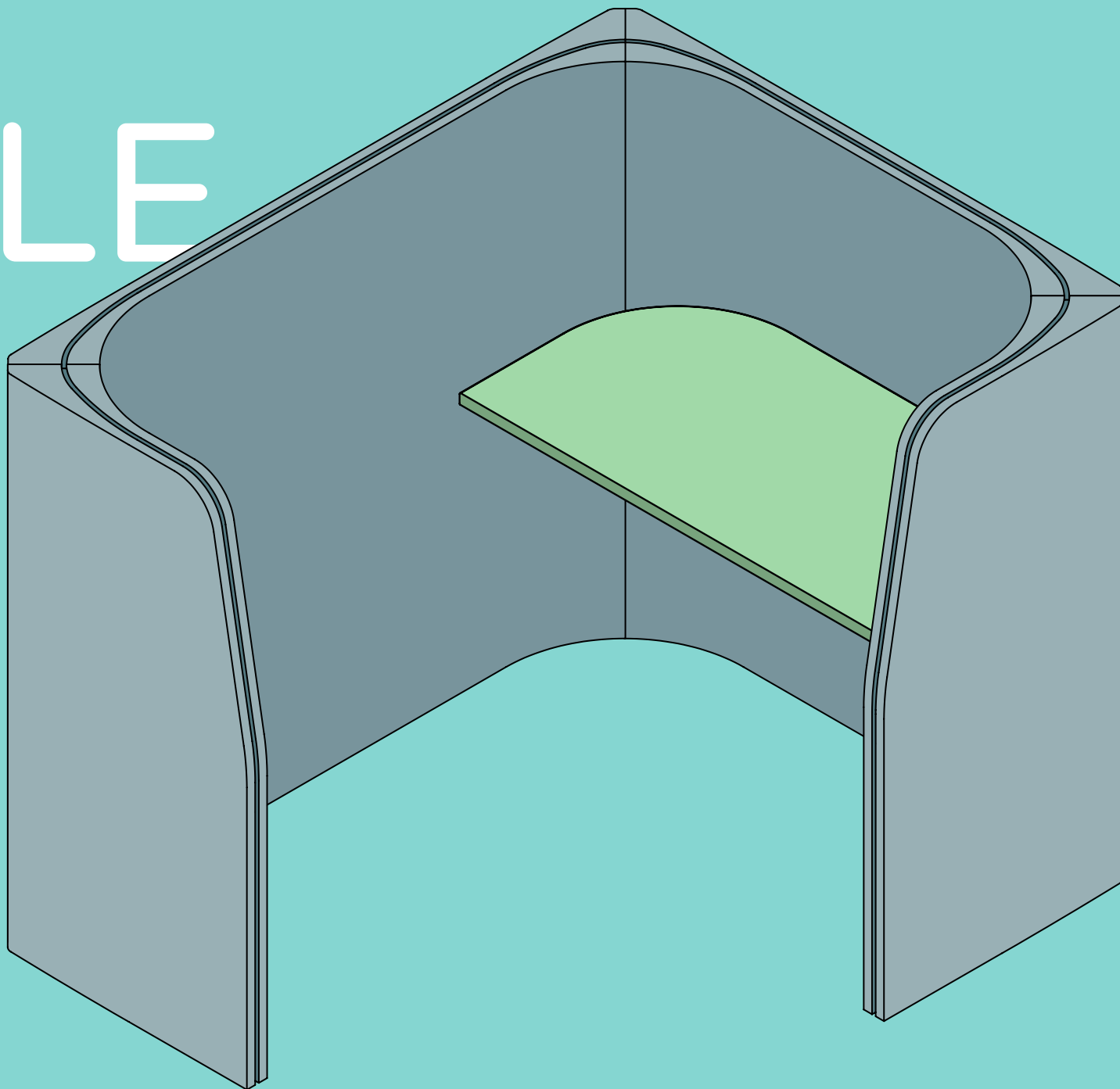

TABLE FOR ONE

Table for One is a destination touch-down point which offers privacy for individual focused work. Suitable for mobile team members who need a spot to work but don't require a dedicated desk.

The soft, upholstered walls absorb noise common in today's open-plan office and provide shelter from both visual and acoustic distractions.

The inclusion of world-leading, exclusive nanofibre technology

in the upholstery results in superior acoustic performance.

Internally-routed cable management facilitates power and data solutions built into the work surface.

Can be placed as a stand-alone unit or combined together to create groups of 2 or 4 pods.

The pod can be adjusted to a left- or right-handed opening.

OPTIONS

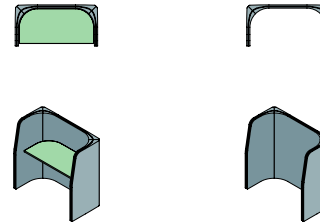

Task desk

Storage / printer bay

INGREDIENTS

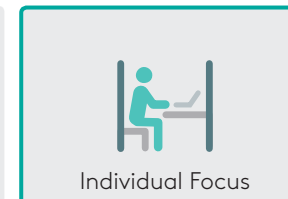

1 user
L 1,600mm
W 1,300mm
H 1,300mm



FABRIC
INSIDE 5.3m²
OUTSIDE 5.3m²
SEATING N/A

PRIVATE DINER

FOR TWO

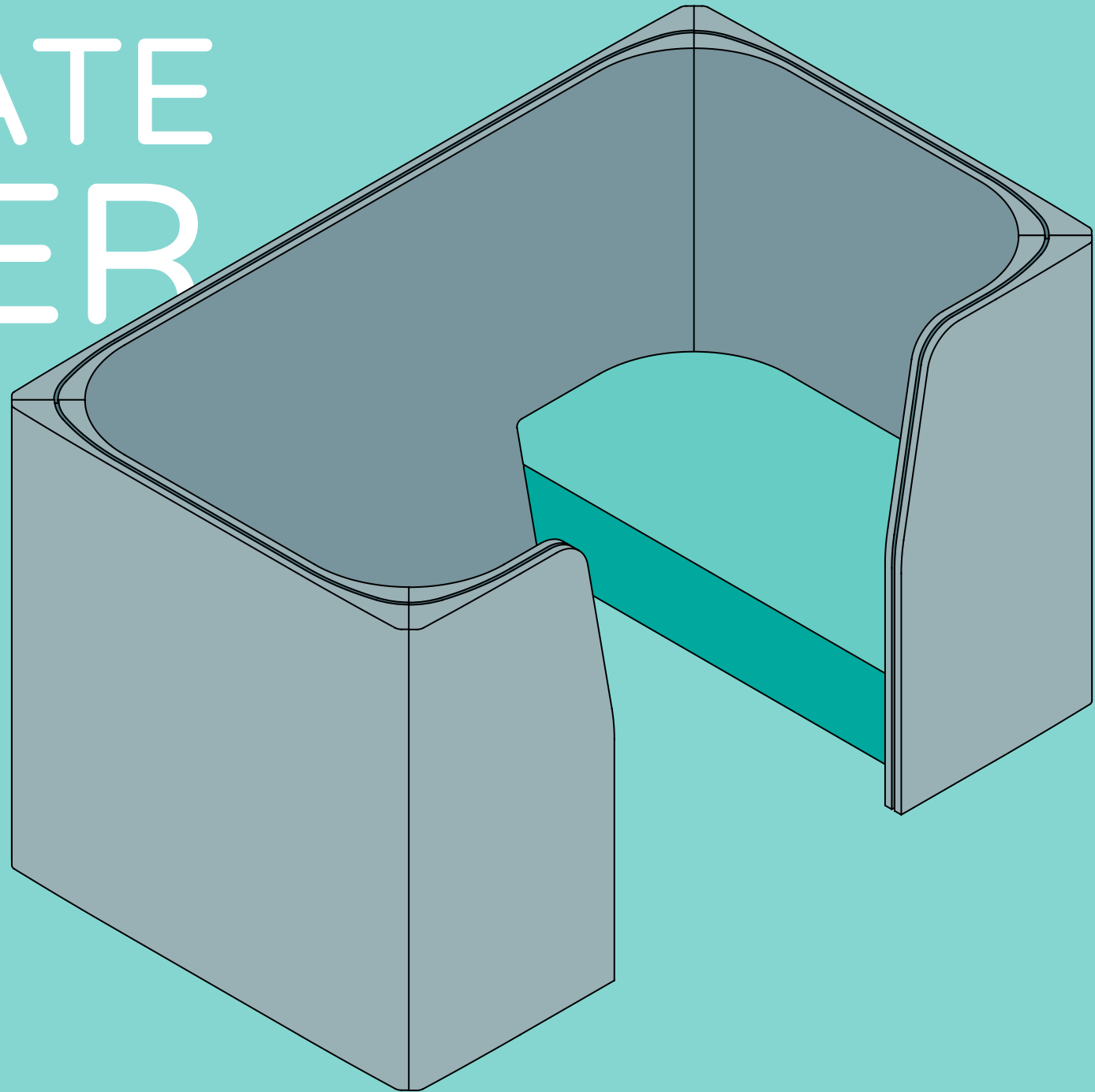

PRIVATE DINER FOR TWO

Private Diner for Two provides a private collaborative work space for two within the open office. Comfortable seating and upholstered walls create an inviting space for private meetings or as a quiet retreat for an individual.

The free-standing unit can be placed anywhere in the office and can move and suits clients who require flexibility in their floorplate.

The soft, upholstered walls which incorporate exclusive

nanofibre technology, help mitigate the impact of noise and collaborative efforts. This means both those inside and outside the pod can work more productively, free of distraction.

Add a table or a computer monitor to create a perfect spot for multi-media presentations or video-conferencing.

Internally-routed cable management facilitates power and data solutions built into the work surface.

OPTIONS

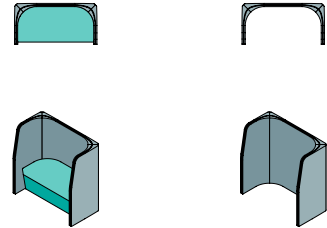

Lounge seating

Storage / printer bay

INGREDIENTS

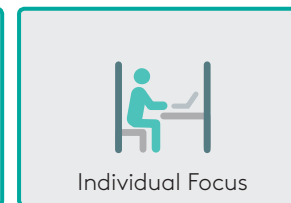

👤👤 1-2 users
 L 2,200mm
 W 1,300mm
 H 1,300mm



FABRIC
 INSIDE 7.5m²
 OUTSIDE 7.5m²
 SEATING 3.2m²

PRIVATE DINER

FOR FOUR

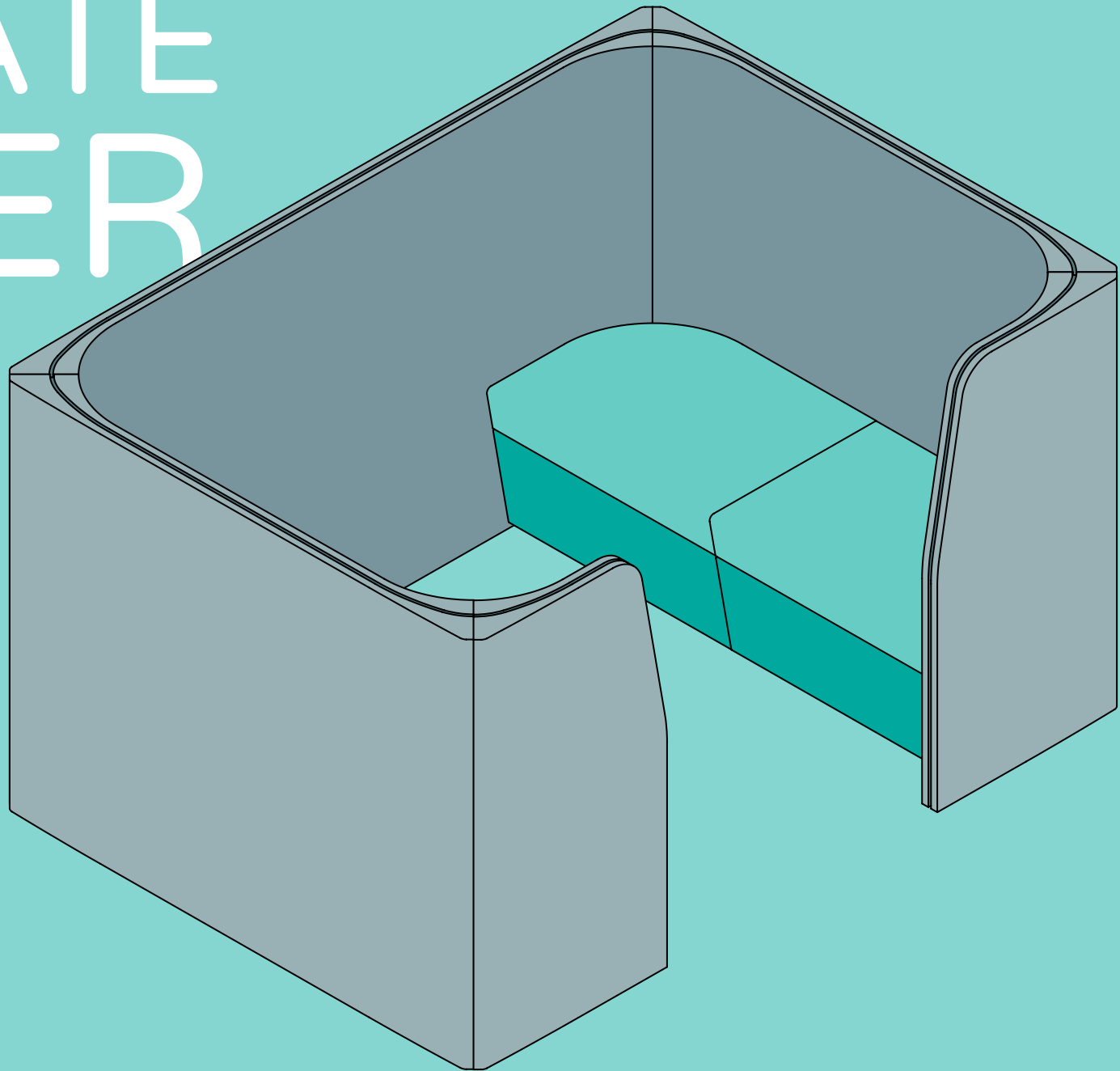

PRIVATE DINER FOR FOUR

Private Diner for Four provides a private collaborative work space within the open office for two to four users. Comfortable seating and upholstered walls create an inviting space for private meetings.

The free-standing unit can be placed anywhere in the office and can move to suit clients

who require flexibility in their floorplate.

The soft, upholstered walls which incorporate exclusive nanofibre technology, help mitigate the impact of noise and collaborative efforts. This means both those inside and outside the pod can work more productively, free of distraction.

Add a table or a computer monitor to create a perfect spot for multi-media presentations or video-conferencing.

Internally-routed cable management facilitates power and data solutions built into the work surface.

OPTIONS

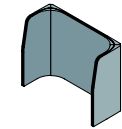
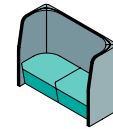
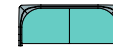

Lounge seating

Storage / printer bay

INGREDIENTS

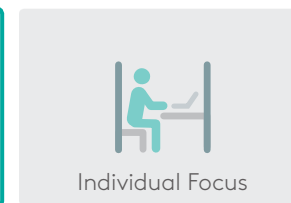

👤 2-4 users
 L 2,200mm
 W 1,600mm
 H 1,300mm



FABRIC
 INSIDE 8.1m²
 OUTSIDE 8.1m²
 SEATING 6m²

PRIVATE DINER

FOR
FOUR
PLUS

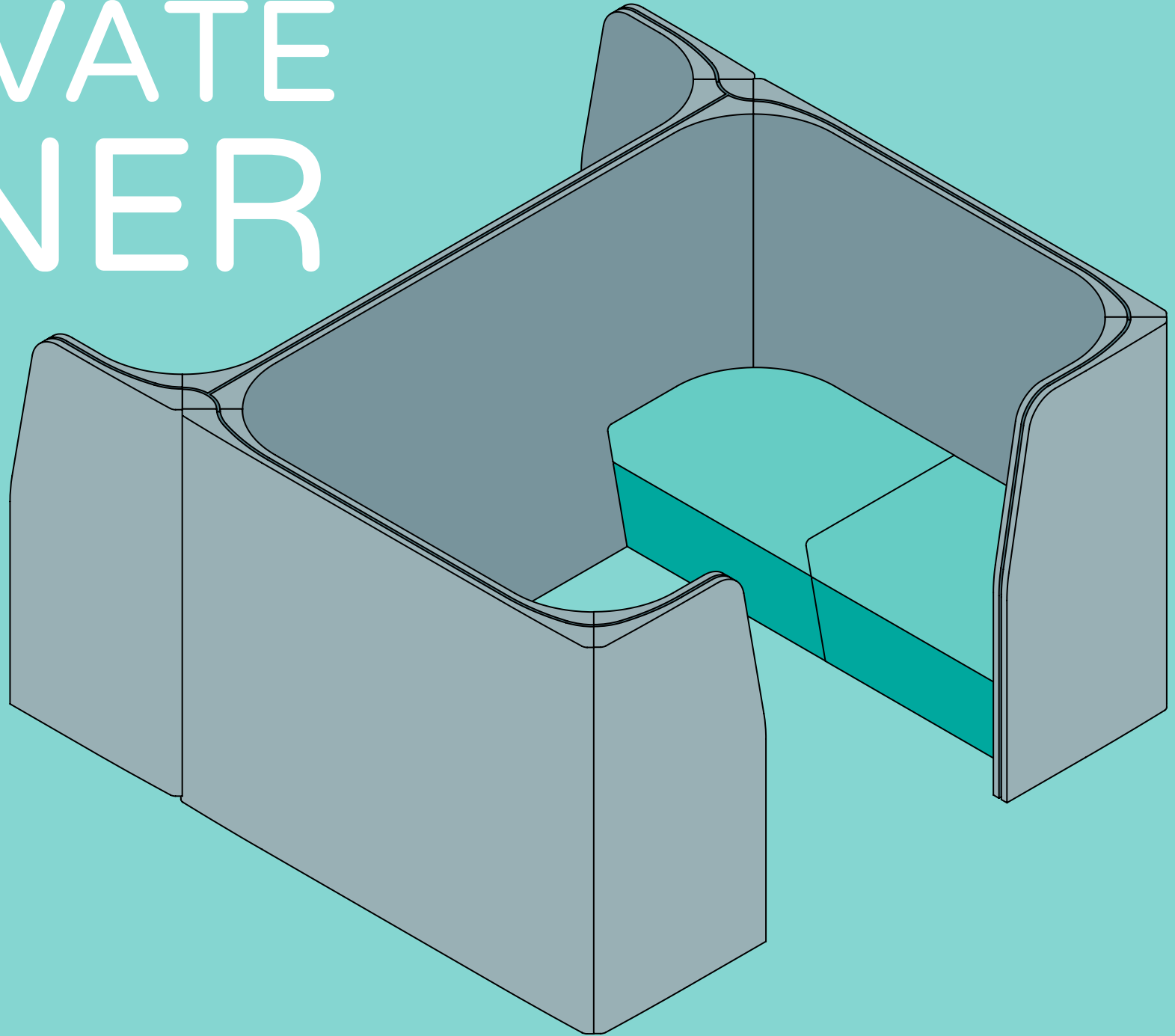

PRIVATE DINER FOR FOUR - PLUS

Private Diner for Four Plus provides a collaborative work space for four to six users. The adjacent seating area provides an open collaborative space for more informal meetings within the open office.

Comfortable seating and upholstered walls create an inviting space for private meetings. The free-standing pod can be placed anywhere in the office and can move to suit clients who require flexibility in their floorplate.

The soft, upholstered walls which incorporate exclusive nanofibre technology, help mitigate the impact of noise and collaborative efforts. This means both those inside and outside the pod can work more productively, free of distraction.

Add a table or a computer monitor to create a perfect spot for multi-media presentations or video-conferencing.

Internally-routed cable management facilitates power and data solutions built into the work surface.

OPTIONS

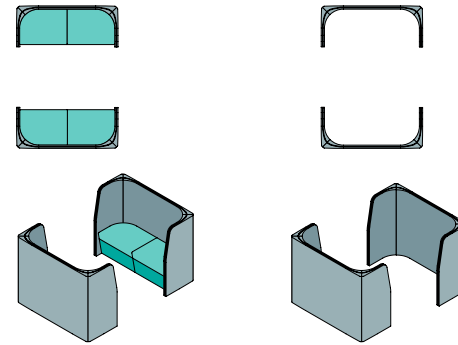

Lounge seating

Screens

INGREDIENTS

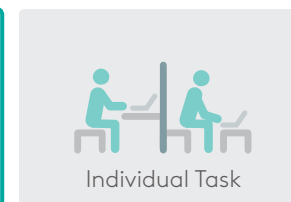
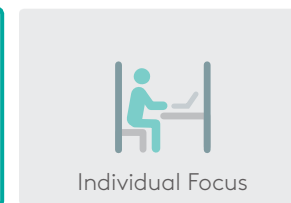
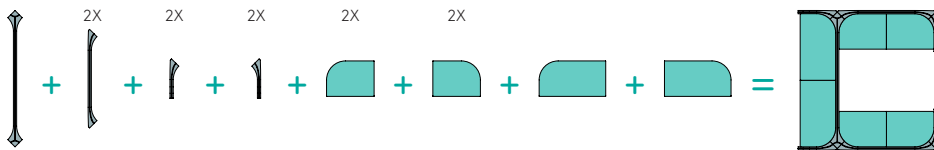

4-6 users
 L 2,200mm
 W 2,250mm
 H 1,300mm

FABRIC
 INSIDE 10.1m²
 OUTSIDE 10.1m²
 SEATING 13.2m²

DEGU STATION TASK

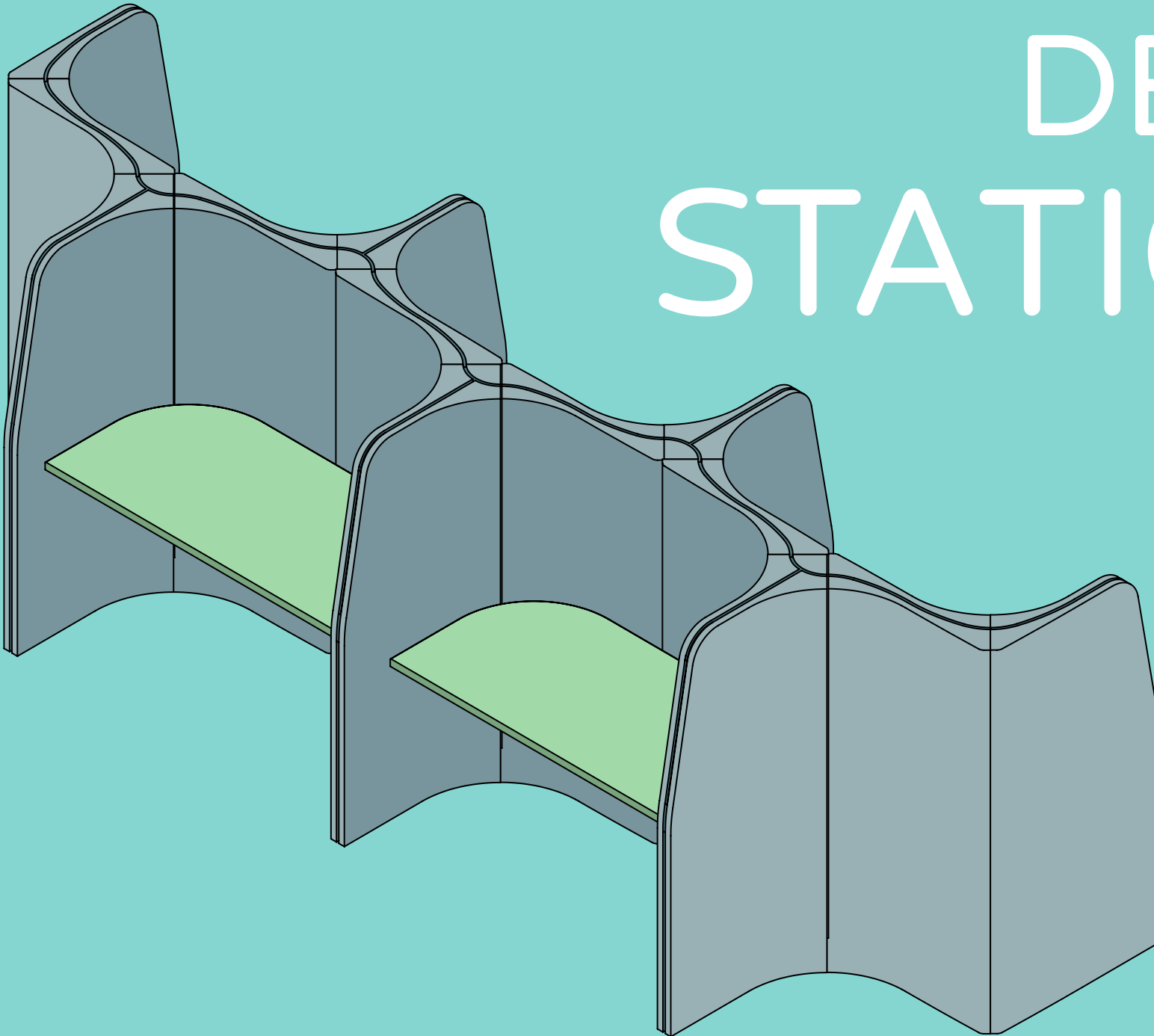

DEGUSTATION TASK

DeGuStation Task provides flexible desking for five. Suitable for assigned seating or for mobile team members who need a spot to work but don't require a dedicated desk.

The unit can easily be scaled up or down in size by adding or removing "ingredients" depending on current needs.

Add seating for additional collaborative or drop-in meeting areas for managerial staff.

The soft, upholstered walls absorb noise common in today's

open-plan office and provide shelter from both visual and acoustic distractions.

The inclusion of world-leading, exclusive nanofibre technology in the upholstery results in superior acoustic performance.

Internally-routed cable management facilitates power and data solutions built into the work surface.

OPTIONS

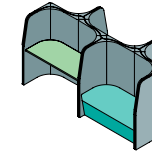
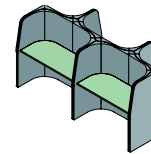
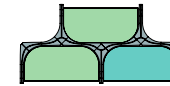
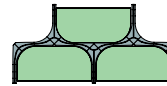

Task desks for three.

Desks and seating for drop-in meetings

INGREDIENTS

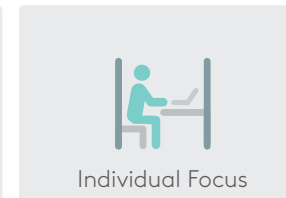

5 users
 L 4,080mm
 W 1,300mm
 H 1,300mm



FABRIC
 INSIDE 13m²
 OUTSIDE 13m²
 SEATING N/A

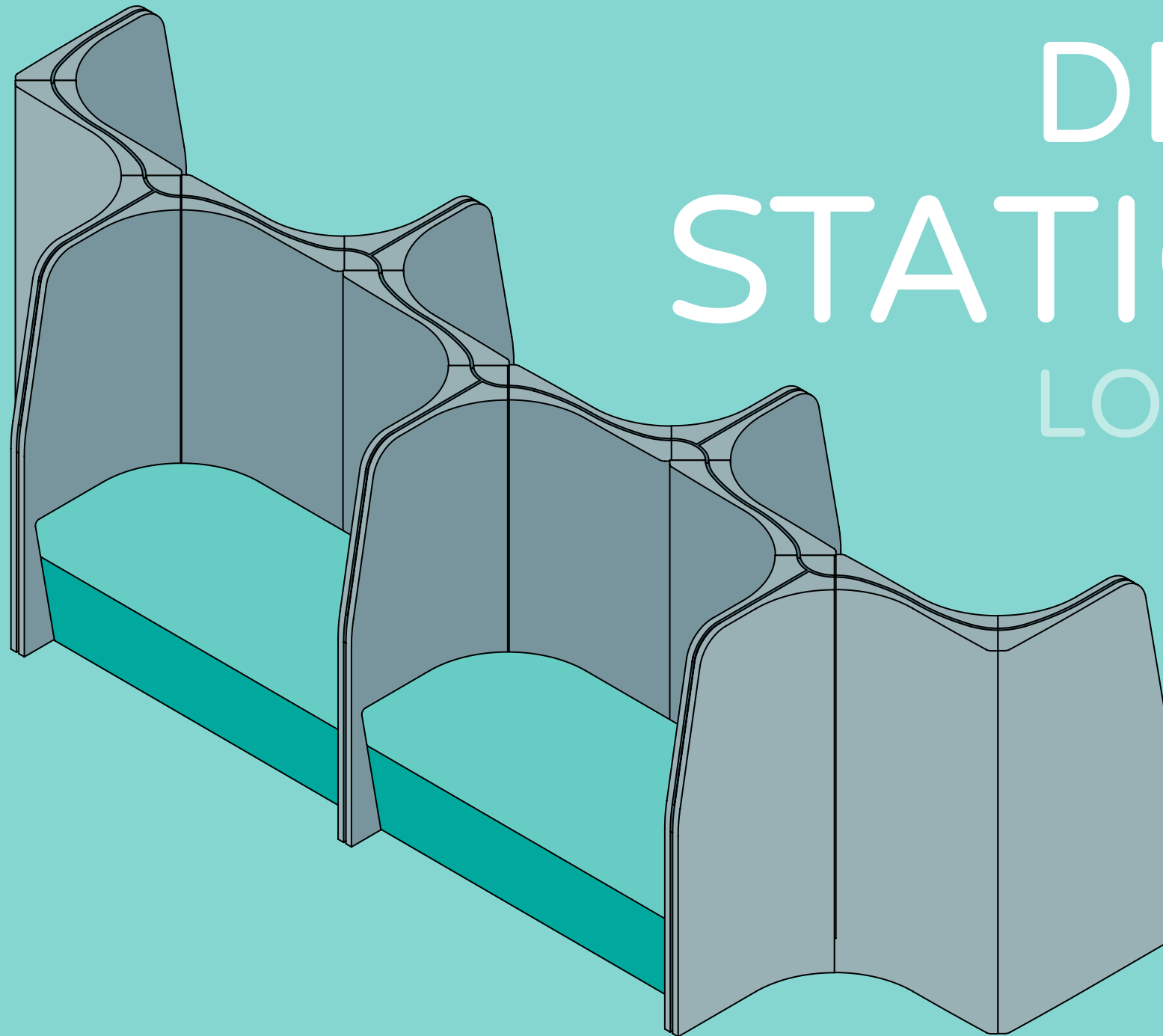

DEGU
STATION
LOUNGE

DEGUSTATION LOUNGE

DeGuStation Lounge provides open collaborative work space for five to ten users. The unit can easily be scaled up or down in size by adding or removing "ingredients" depending on current needs.

Can be reconfigured by adding additional seating or desking depending on requirements.

The soft, upholstered walls absorb noise common in today's open-plan office and provide shelter from both visual and acoustic distractions.

The inclusion of world-leading, exclusive nanofibre technology in the upholstery results in superior acoustic performance.

Internally-routed cable management facilitates power and data solutions built into the work surface.

OPTIONS

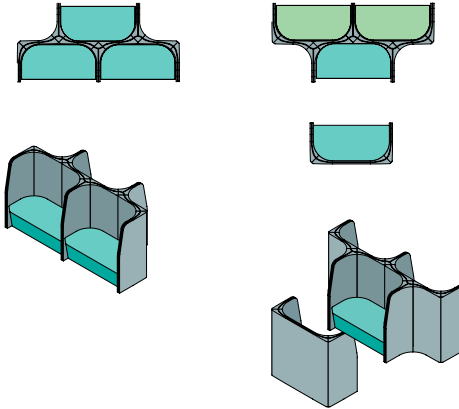

Seating for 3 - 6.

Desks and seating for drop-in meetings

INGREDIENTS

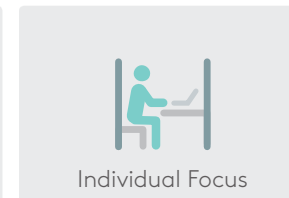

👤 5-10 users
 L 4,080mm
 W 1,300mm
 H 1,300mm



FABRIC
 INSIDE 13m²
 OUTSIDE 13m²
 SEATING 8m²

BANQUET CORNER

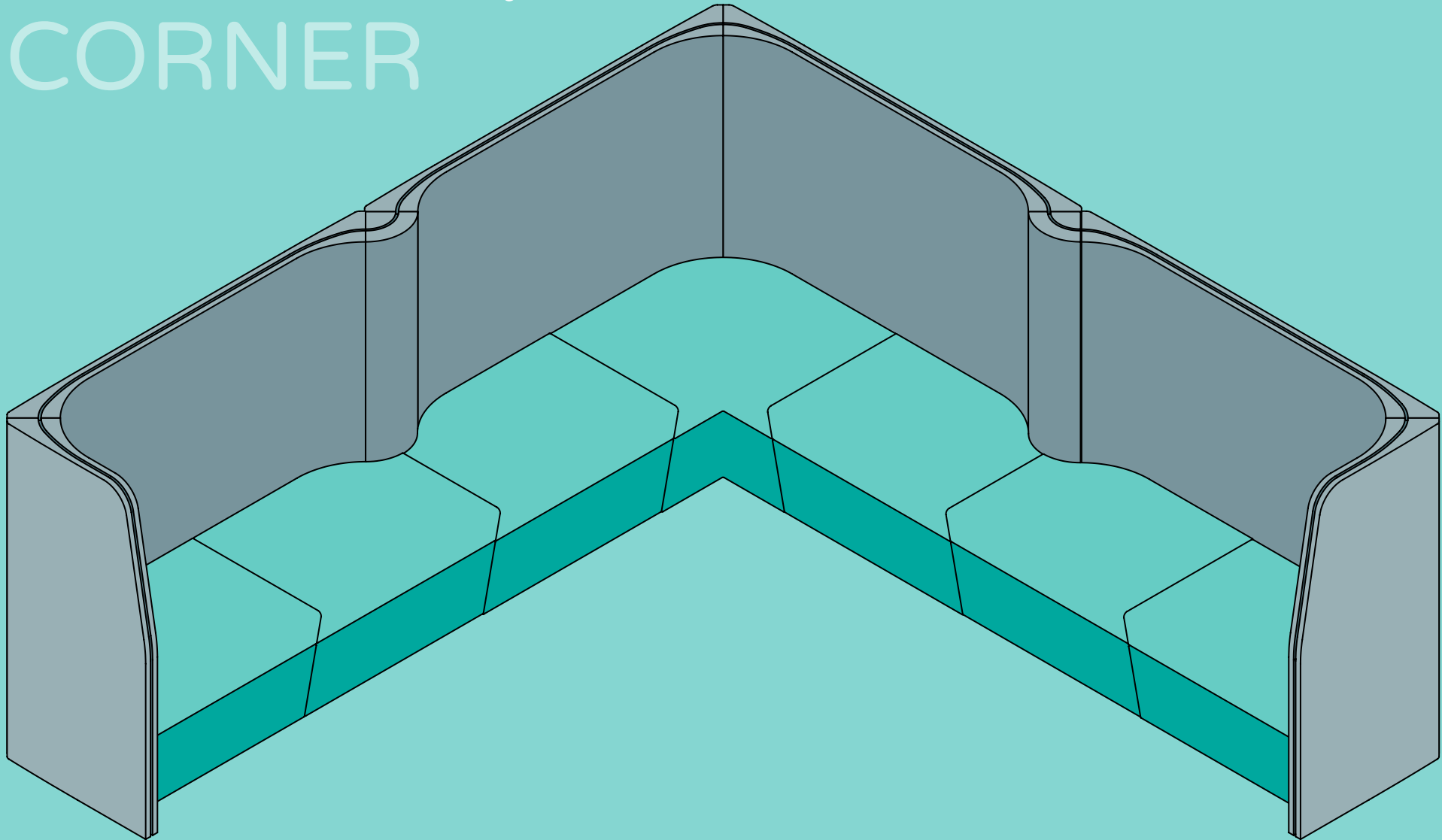

BANQUET CORNER

Banquet Corner offers a larger breakout space for open collaboration or socialising for four to six users. Perfect for dining areas, the soft walls provide a level of acoustic privacy.

Can be scaled up or down depending on requirements.

The soft, upholstered walls absorb noise common in today's open-plan office and provide shelter from both visual and acoustic distractions.

The inclusion of world-leading, exclusive nanofibre technology in the upholstery results in superior acoustic performance.

Internally-routed cable management facilitates power and data solutions built into the work surface.

OPTIONS

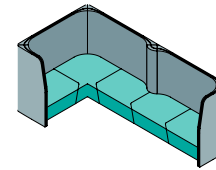
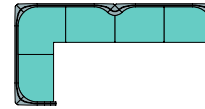

INGREDIENTS

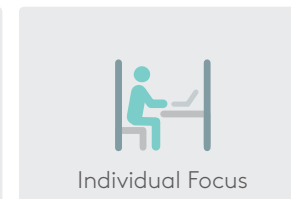
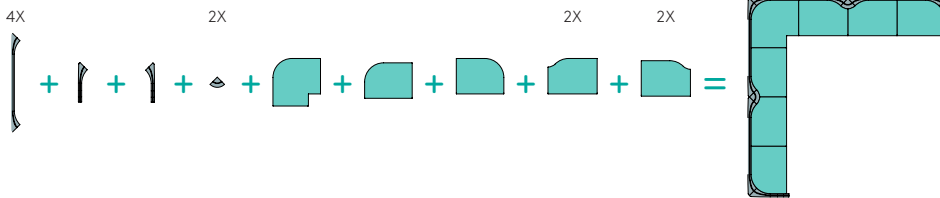

4-6 users
 L 3,200mm
 W 3,200mm
 H 1,300mm

FABRIC
 INSIDE 10m²
 OUTSIDE 10m²
 SEATING 10.5m²

BANQUET

PLUS

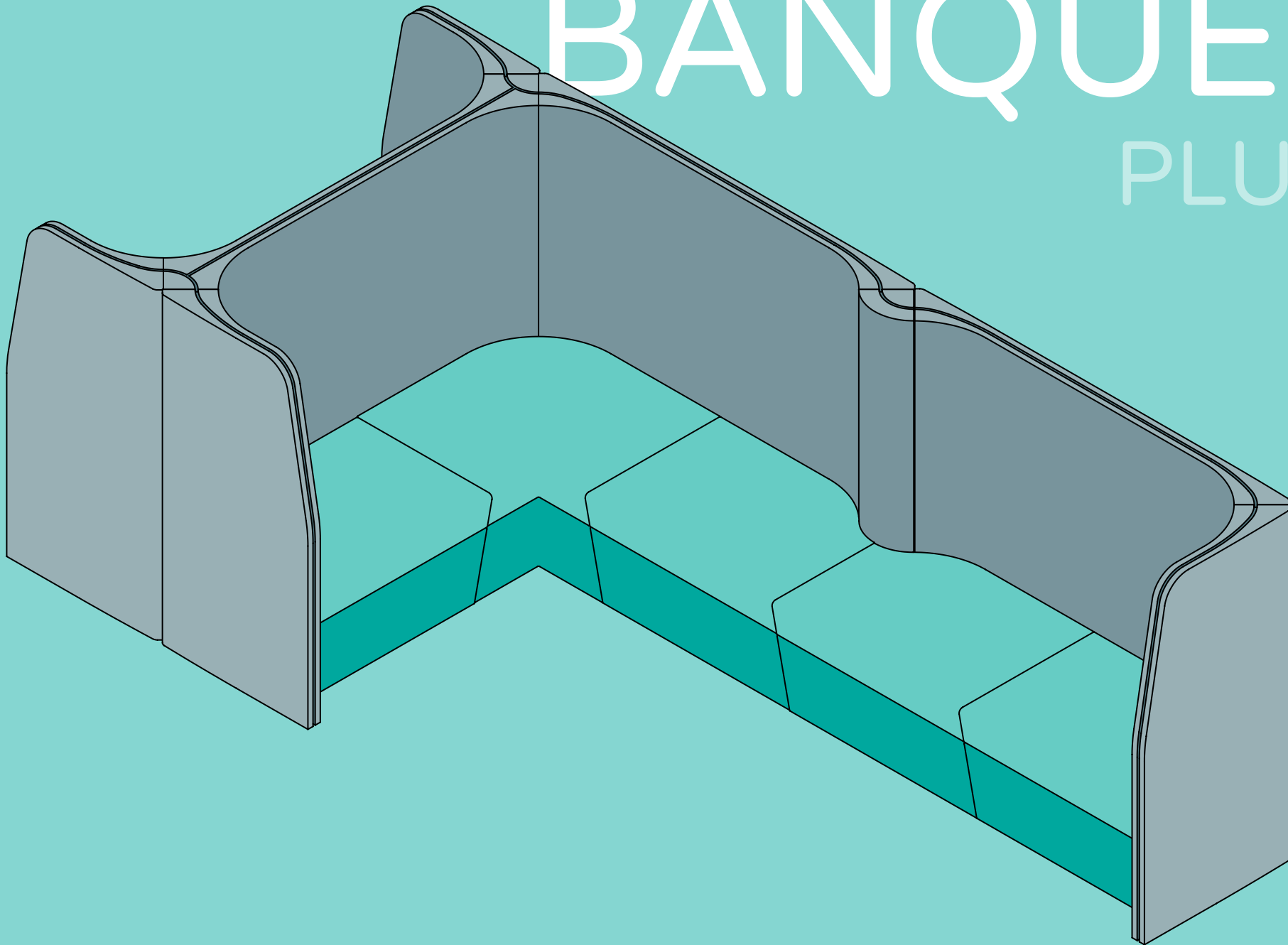

BANQUET PLUS

Banquet Plus offers a breakout space for open collaboration or socialising. The adjacent standing desk provides a bar seating area for two informal meetings or task work. The unit can be scaled up or down depending on requirements.

The soft, upholstered walls absorb noise common in today's open-plan office and provide shelter from both visual and acoustic distractions.

The inclusion of world-leading, exclusive nanofibre technology in the

upholstery results in superior acoustic performance.

Internally-routed cable management facilitates power and data solutions built into the work surface.

OPTIONS

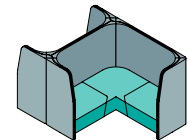
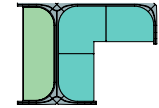

INGREDIENTS

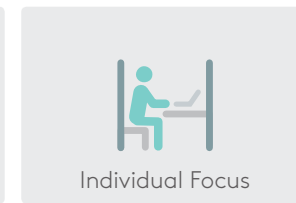
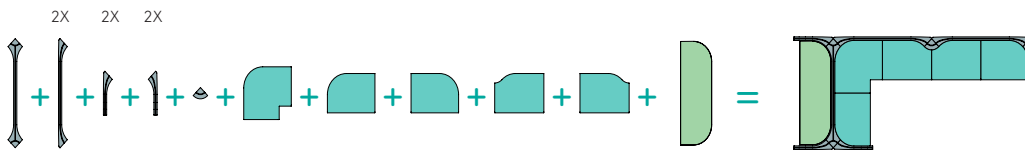

 3-5 users
L 3,850mm
W 1,600mm
H 1,300mm



FABRIC
INSIDE 9.8m²
OUTSIDE 9.8m²
SEATING 7.5m²

PETIT FOUR

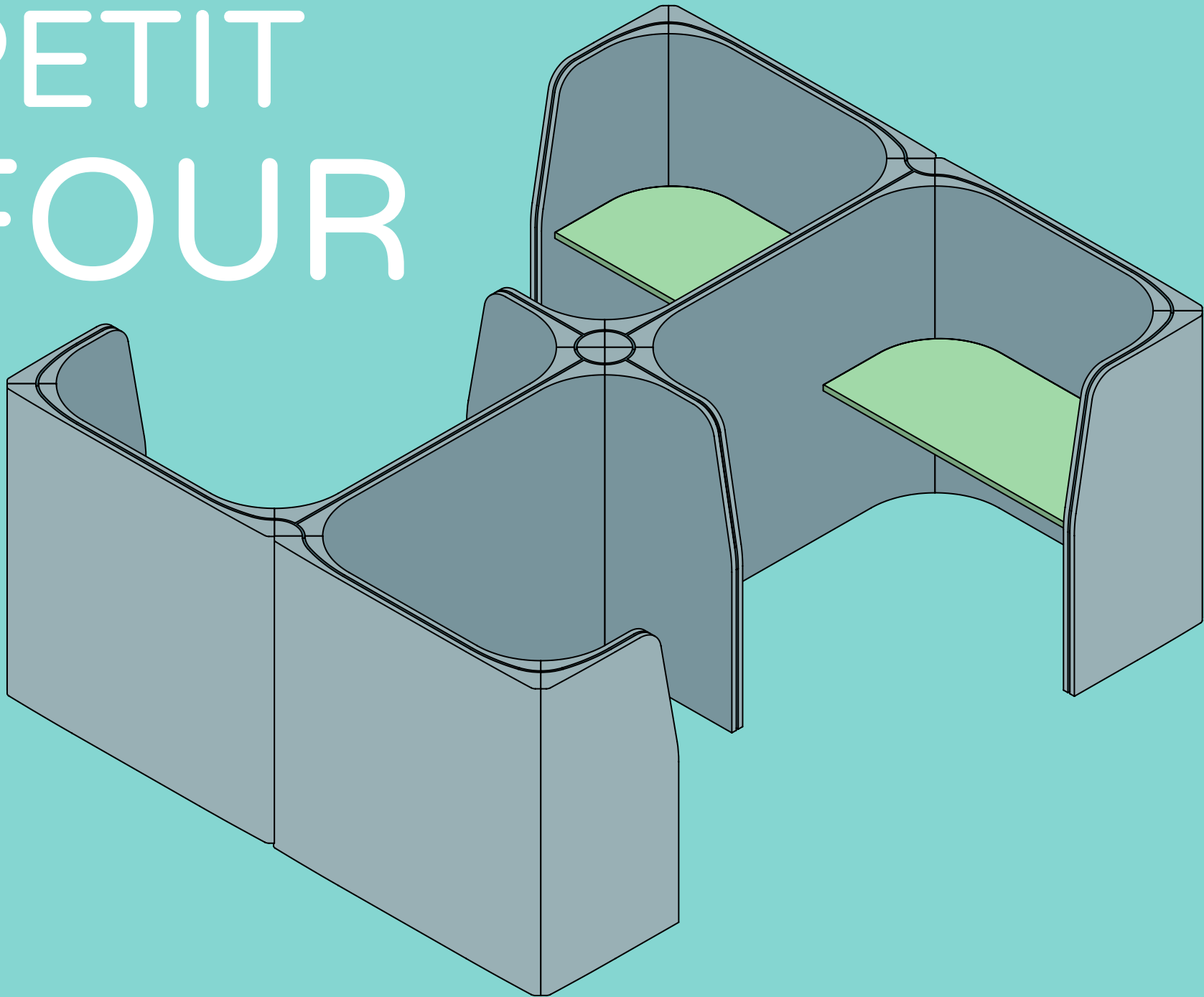

PETIT FOUR

Petit Four is a destination touch-down point which offers a privacy for individual focused work for four. Suitable for mobile team members who need a spot to work but don't require a dedicated desk.

The soft, upholstered walls absorb noise common in today's open-plan office and provide shelter from both visual and acoustic distractions.

The inclusion of world-leading, exclusive nanofibre technology in the upholstery results in superior acoustic performance.

Internally-routed cable management facilitates power and data solutions built into the work surface.

Can be scaled down into smaller units of two.

OPTIONS

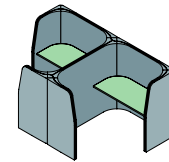
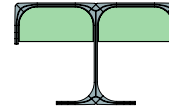

INGREDIENTS

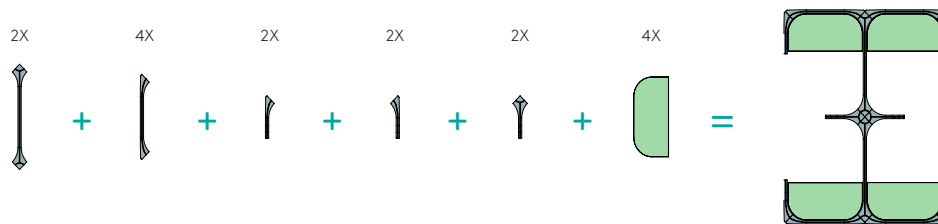

4 users
 L 2,600mm
 W 3,200mm
 H 1,300mm

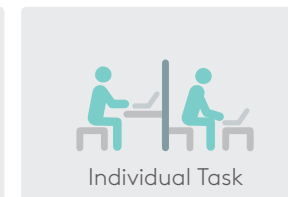

FABRIC
 INSIDE 15.6m²
 OUTSIDE 15.6m²
 SEATING N/A

PICNIC TABLE

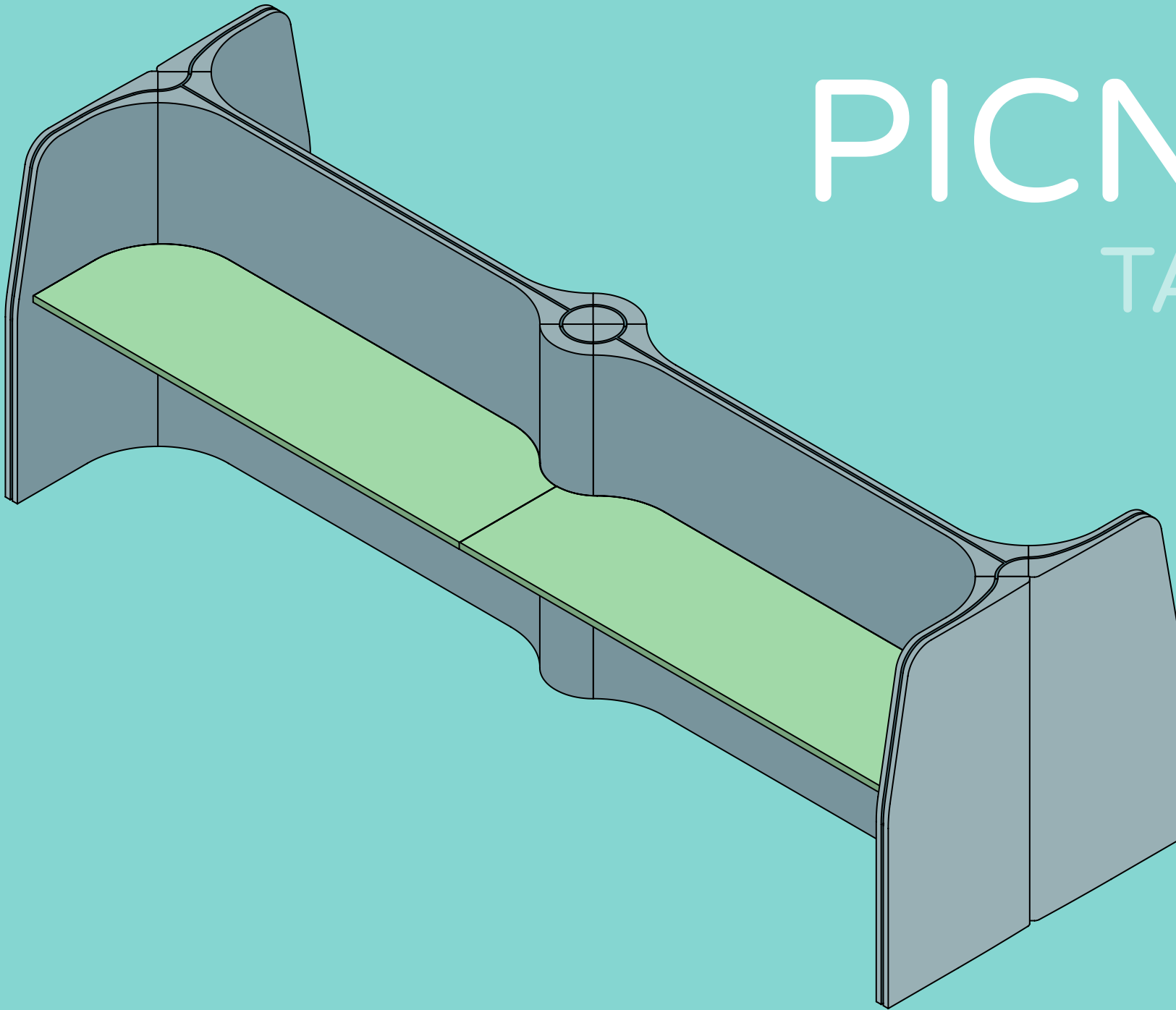

PICNIC TABLE

Picnic Table provides wide, spacious task desks for individual work or "duo" workstyles where people can work side-by-side for spontaneous collaboration for four to eight users.

Suitable for assigned seating or for mobile team members who need a spot to work but don't require a dedicated desk.

Add short walls between the desks for more privacy. Seating can provide additional collaborative or drop-in meeting areas for managerial staff.

The soft, upholstered walls absorb noise common in today's open-plan office and provide shelter from both visual and acoustic distractions.

The inclusion of world-leading, exclusive nanofibre technology in the upholstery results in superior acoustic performance.

Internally-routed cable management facilitates power and data solutions built into the work surface.

OPTIONS

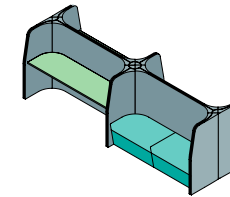
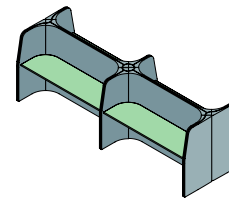
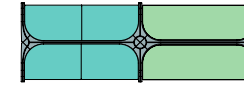
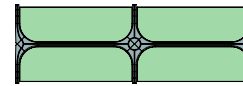

Add walls for additional privacy

Desks and seating for drop-in meetings

INGREDIENTS

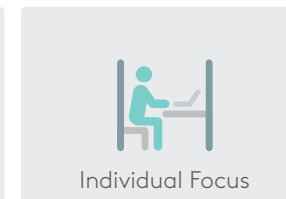
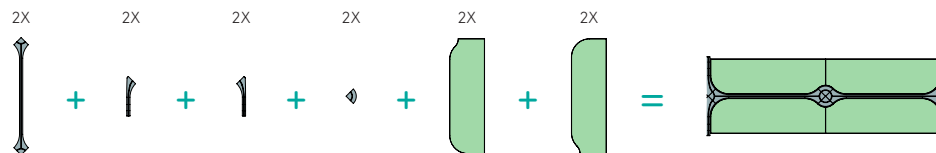

 4-8 users
 L 3,800mm
 W 1,300mm
 H 1,300mm

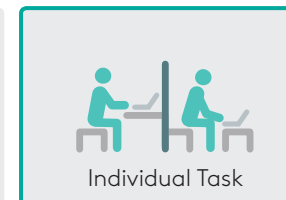

FABRIC
 INSIDE 9m²
 OUTSIDE 9m²
 SEATING N/A

PICNIC BENCH

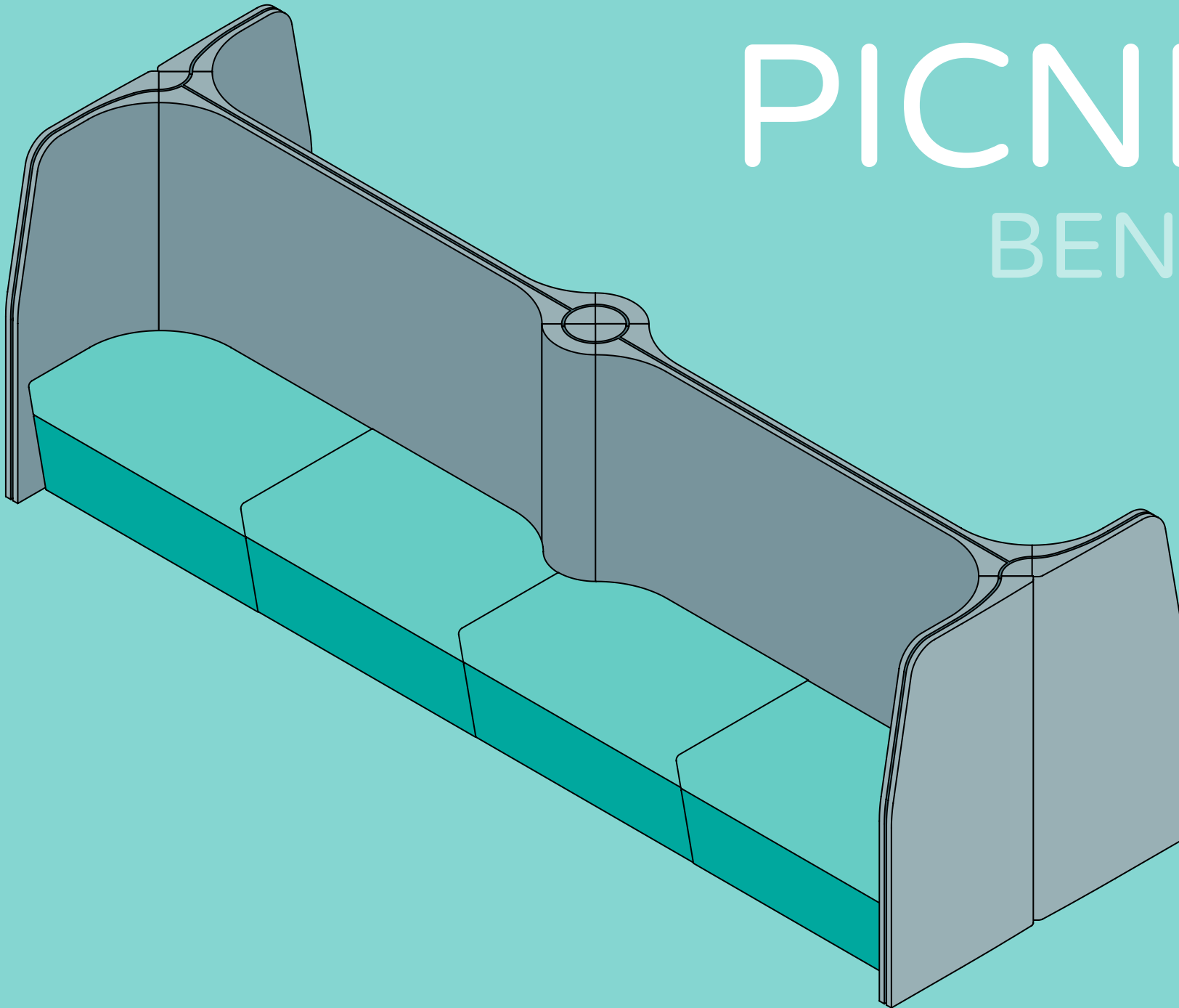

PICNIC BENCH

Picnic Bench provides wide, spacious collaborative seating for four to six users.

Add short walls between the seats for more privacy. Desks can provide additional collaborative or drop-in meeting areas for managerial staff.

The soft, upholstered walls absorb noise common in today's open-plan office and provide shelter from both visual and acoustic distractions.

The inclusion of world-leading, exclusive nanofibre technology in the upholstery results in superior acoustic performance.

Internally-routed cable management facilitates power and data solutions built into the work surface.

OPTIONS

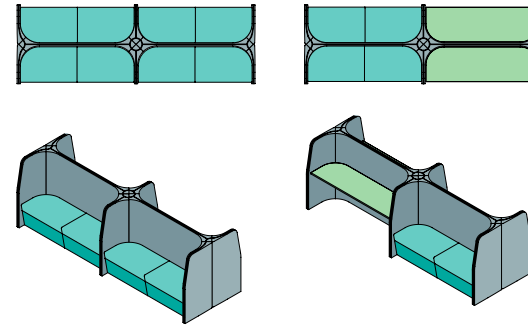

Add walls for additional privacy

Desks and seating for drop-in meetings

INGREDIENTS

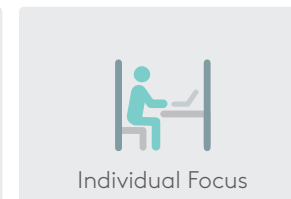
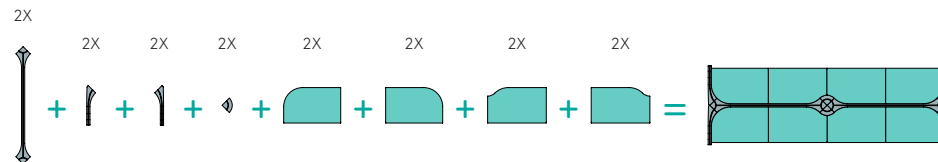

 4-6 users
 L 3,800mm
 W 1,300mm
 H 1,300mm



FABRIC
 INSIDE 9m²
 OUTSIDE 9m²
 SEATING 12m²

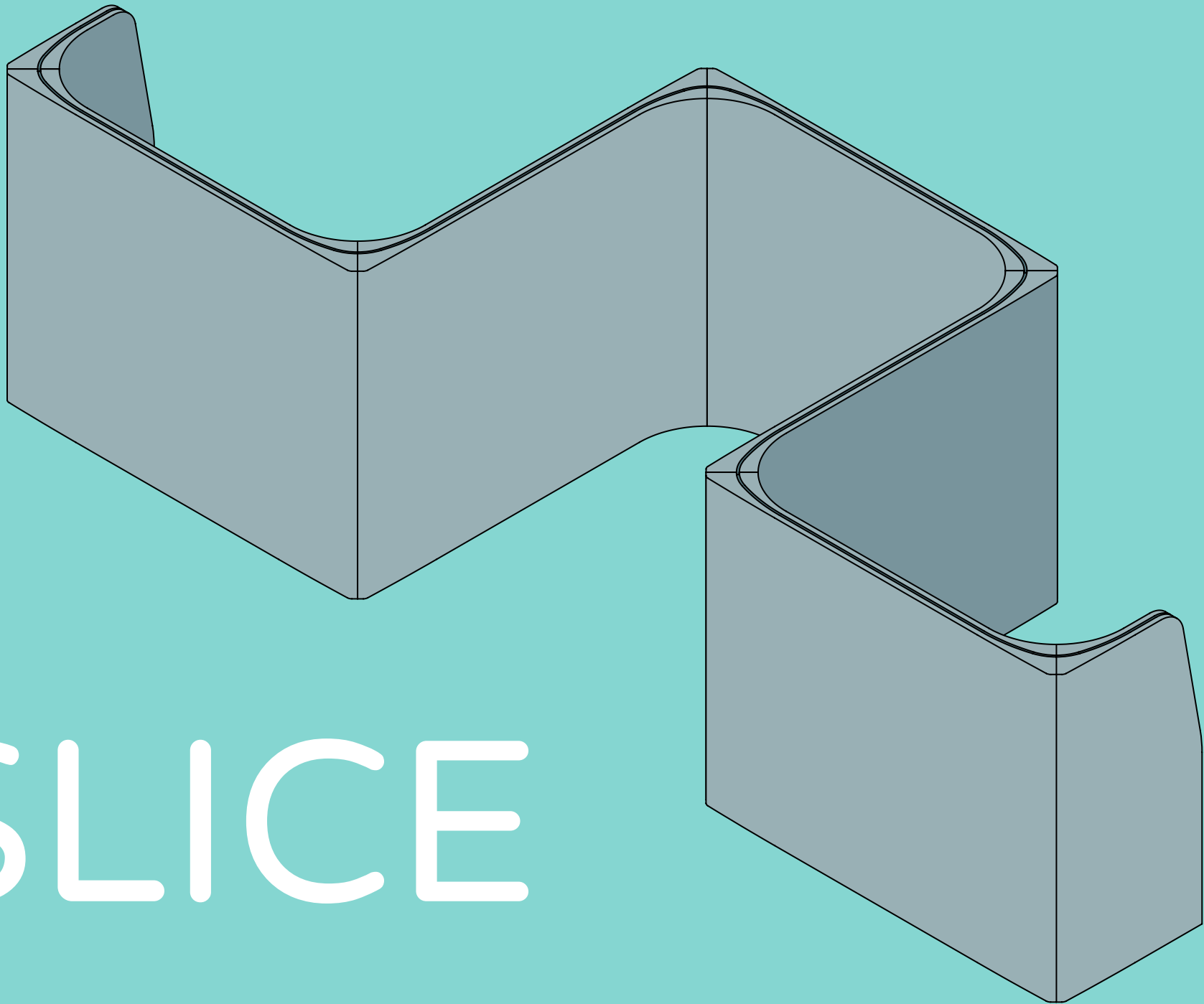

SLICE

SLICE

Slice provide flexible, freestanding screens that support and define private areas.

Add seats or desks as required.

The soft, upholstered walls absorb noise common in today's open-plan office and provide shelter from both visual and acoustic distractions.

The inclusion of world-leading, exclusive nanofibre technology in the upholstery results in superior acoustic performance.

Internally-routed cable management facilitates power and data solutions built into the work surface.

OPTIONS

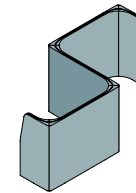
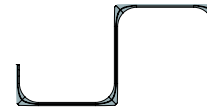

Scale up or down.

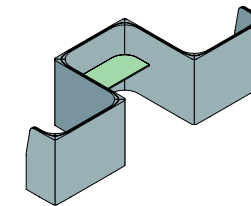
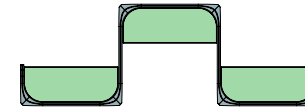

Add desks for workspaces.

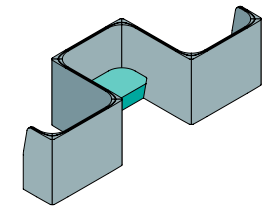
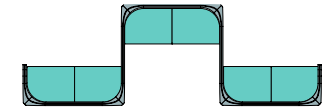

Add seating for quiet task areas.

INGREDIENTS



L 4,800mm
W 1,600mm
H 1,300mm

FABRIC

INSIDE 9m²

OUTSIDE 9m²

The Icing on the Cake

Sustainable, Kiwi design and manufacturing saves you money in the long run.

Designed and manufactured in New Zealand, Keystone™ is made with quality materials built to be durable and withstand frequent reconfiguration and storage.

\$ Cost Savings: Keystone™'s flexible and reconfigurable design, and shared wall system, helps combat ongoing spending and quality issues - saving your organisation money in the long run.

🌿 Sustainable: Constructed from lightweight, eco-friendly material Keystone™'s individual "ingredients" can be shipped more easily and economically.

↻ Flexibility & Future Proofing: Keystone™ is scalable and flexible, offering users the ability to scale up and down with shifts in staff or changes to office space or location.

📣 Acoustics: Keystone™ uses world-leading application of nanofibre as a substrate, which allows workers to work in close proximity to each other with minimal disruption due to noise

💬 Collaborative: Keystone™ layouts encourage quick, easy collaborations and allow for spontaneous meetings to be held in ways that do not disrupt those involved in concentrated work.

★ Aesthetics: Keystone™ is comfortable, inviting and nurturing of both deep thought and fun, social interactions.

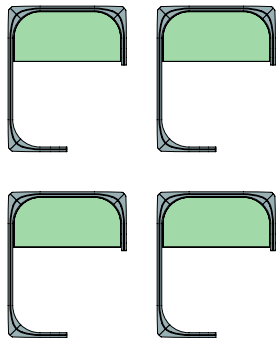

4 X TABLES FOR ONE

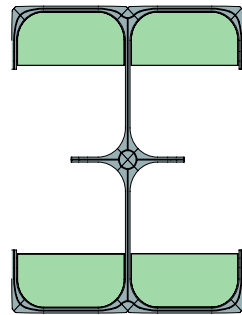

1 X PETIT FOUR
SAVES 25%

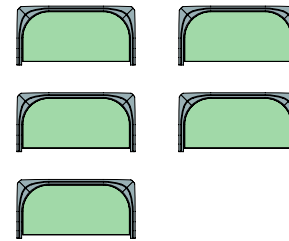

5 X TASK TABLES

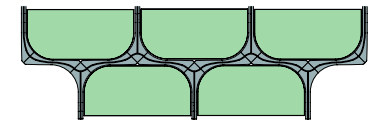

1 X DEGUSTATION TASK
SAVES 17%

The shared wall system results in cost savings.



www.iqcommercial.co.nz