



# CONNECT

# WHY CONNECT ?

In today's workspaces, many businesses are looking for ways to create different zones in open plan areas without building permanent walls.

The Connect Zone Divider system solves this problem, with its multi-purpose design offering the solution to a host of workspace needs all in one system.





## Create Zones

Create different zones within an open plan area.



## Reduce Noise Transfer Between Zones

Acoustic or Acoustic/Fin modules can be incorporated to reduce noise transfer between areas.



## Reconfigure As Needed

A Simple kit of parts allows you to reconfigure as your needs change.



## Incorporate Plants

Plant wall modules allow real or artificial plants to be used.



## Flexible Meeting Spaces

A Range of freestanding meeting rooms for any size meeting, can be relocated or reconfigured as your needs change.



# CONNECT SPACES



**Create Freestanding meeting spaces in any size,  
that can easily be relocated.**

Combine curved, glazed, planter, upholstered or acoustic modules.



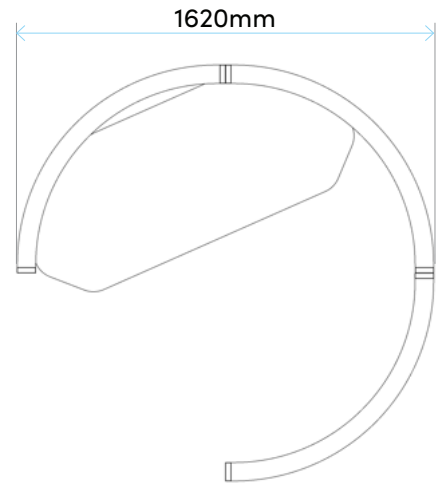

1 Person Focus Space

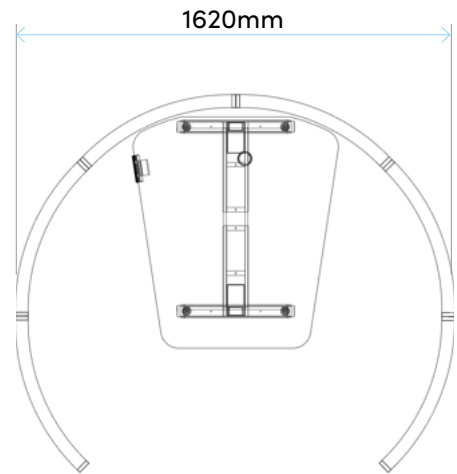
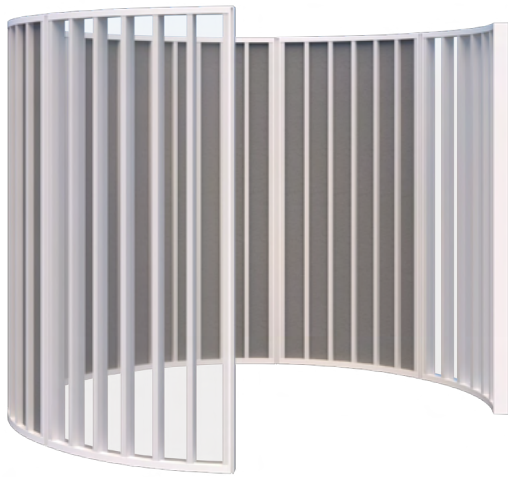

3 Person Meeting Space

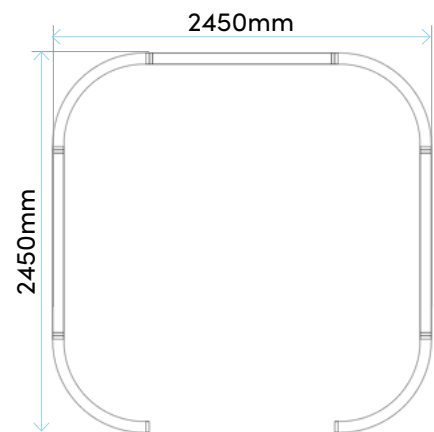

4 Person Meeting Space

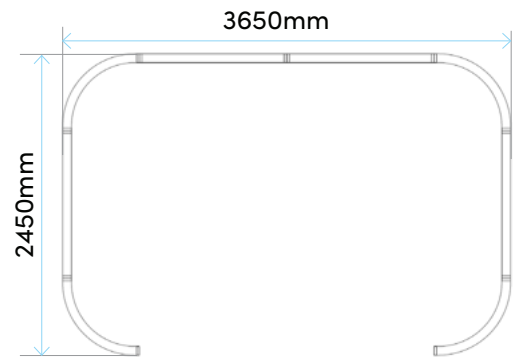

6 Person Meeting Space

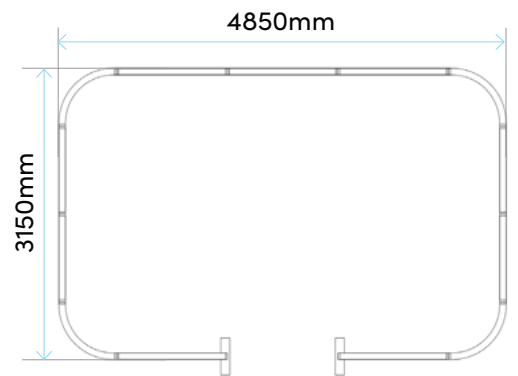

10 Person Meeting Space

## SPECIFICATIONS:

- 1890mm High
- Powder coated aluminum frame, endcaps and feet
- Fins in 25mm Melamine
- 10mm Acoustic panels in-between fins (NRC 0.41)
- 4mm Annealed glass in-between fins on glazed screens
- Recyclable Frame
- 15 Year Warranty
- Custom layouts and finishes for Connect are available, although lead times and pricing may vary

# CONNECT

## ZONE DIVIDERS



**Create zones within open plan spaces.**

Zone areas off by using freestanding screens. Create any combination or length using our standard modules.





## Freestanding Fin Screen

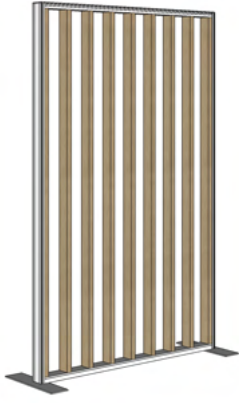

1890H x 1200L



1890H x 1500L

## Freestanding 45° Fin Screen

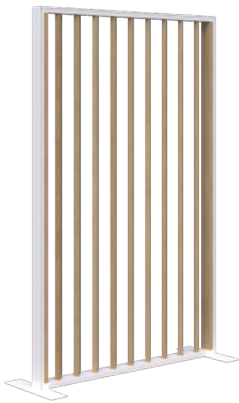

1890H x 1200L



1890H x 1500L

## Freestanding 135° Fin Screen



1890H x 1200L



1890H x 1500L

## Freestanding Plant Wall



1890H x 1200L



1890H x 2400L

## Freestanding Angled Fin/Plant Wall

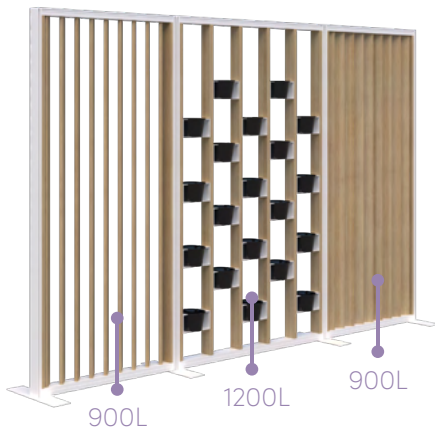

1890H x 3000L

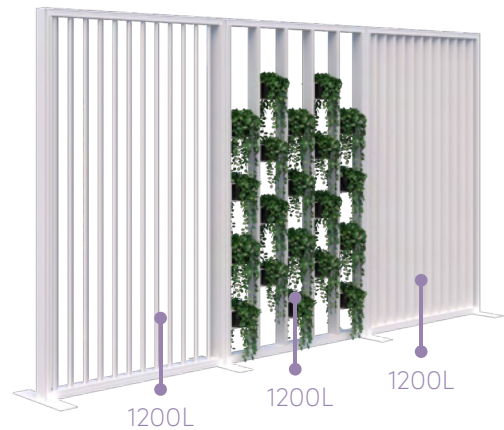

1890H x 3600L

## Freestanding Acoustic Glazed/Plant Wall

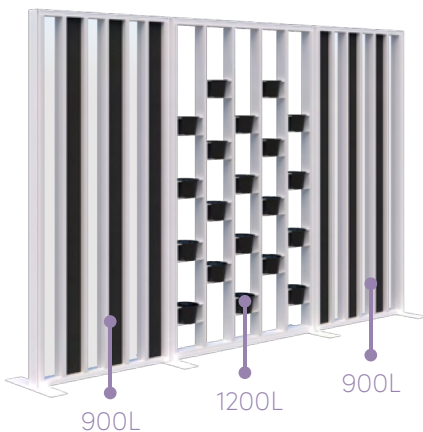

1890H x 3000L

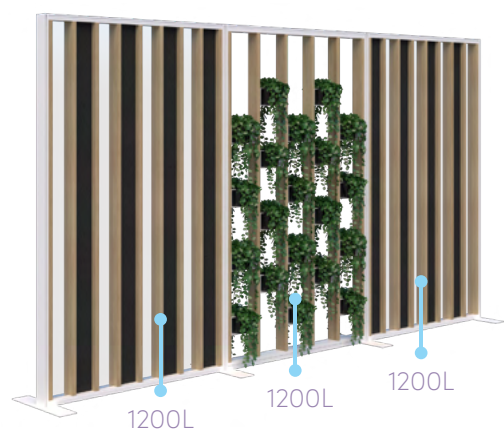

1890H x 3600L

## Freestanding Fabric/Plant Wall

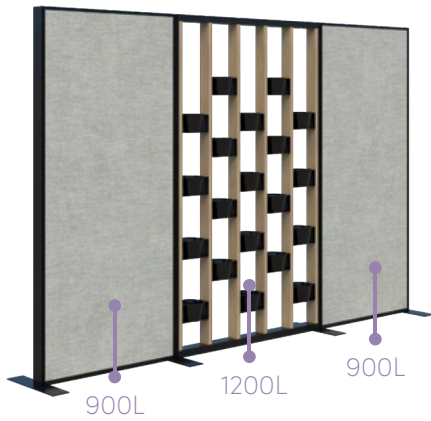

1890H x 1200L

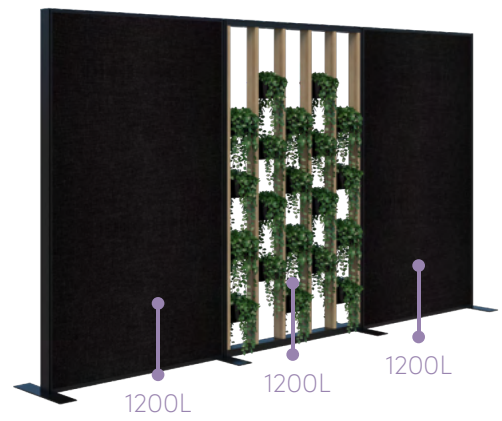

1890H x 2400L

## Freestanding Fabric/Plant Wall/Curved Fin

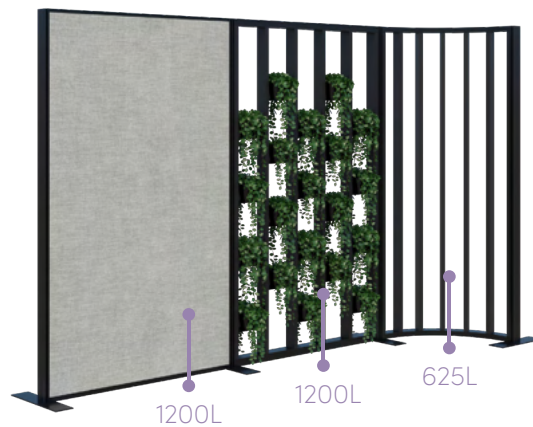

1890H x 3025L

## Freestanding Angled Fin/Whiteboard



1890H x 3000L



1890H x 3600L

## Freestanding Acoustic Glazed/Whiteboard



1890H x 3000L

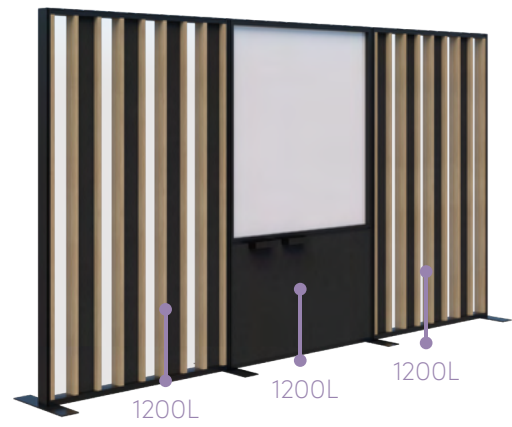

1890H x 3600L

## Freestanding Fabric/Whiteboard

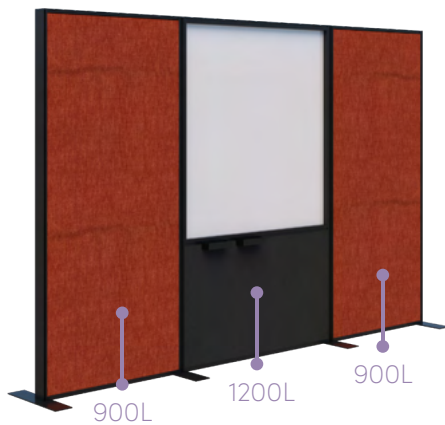

1890H x 3000L

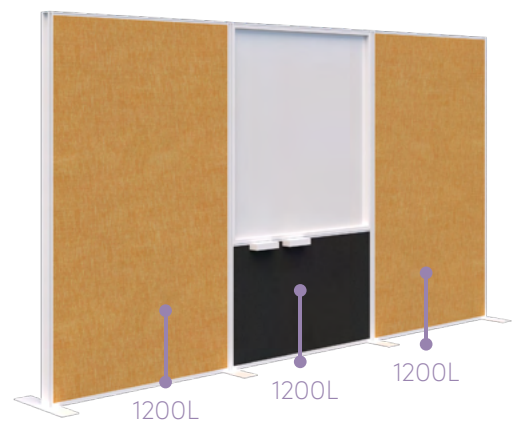

1890H x 3600L

### SPECIFICATIONS:

- 1890mm High
- Powder coated aluminum frame, endcaps and feet
- Fins in 25mm Melamine
- 10mm Acoustic panels in-between fins (NRC 0.41)
- 4mm Annealed glass in-between fins on glazed screens
- 1200mmL Plant Wall is supplied with 20x black 16cm pots, option to upgrade to premium pots
- 1200mmL whiteboard module has two pen trays included
- Recyclable Frame, 15 Year Warranty
- Custom layouts and finishes for Connect are available, although lead times and pricing may vary

# CONNECT

## MODULES & COMPONENTS

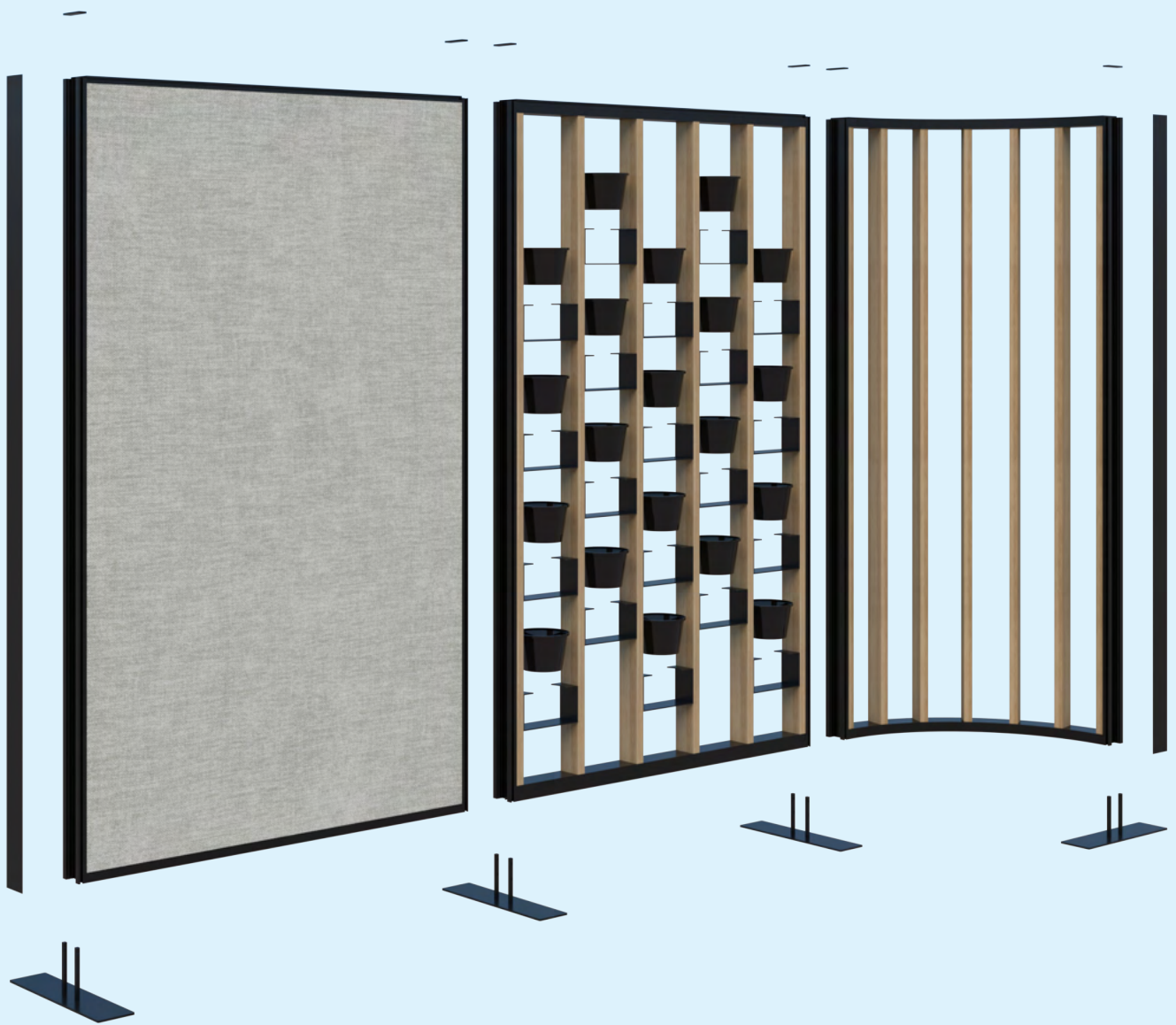

Add acoustic to reduce noise transfer.  
Add glass for visibility while still creating privacy.  
Add plants to bring your spaces to life.



## Fin Straight



1890H x 900L



1890H x 1200L

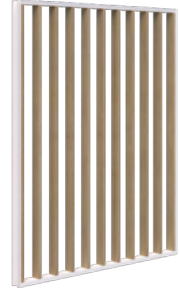

1890H x 1500L

## Fin 45°



1890H x 900L

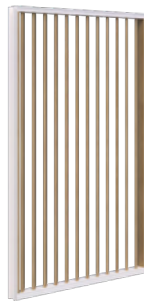

1890H x 1200L

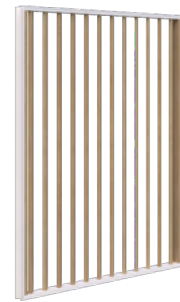

1890H x 1500L

## Fin 135°



1890H x 900L

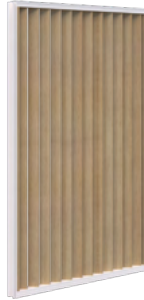

1890H x 1200L



1890H x 1500L

## Fin Glazed



1890H x 900L



1890H x 1200L



## Fin Acoustic



1890H x 900L



1890H x 1200L

## Fin Acoustic Glazed



1890H x 900L



1890H x 1200L

## Fin Plant Wall



1890H x 747L



1890H x 1200L

## Acoustic



1890H x 900L

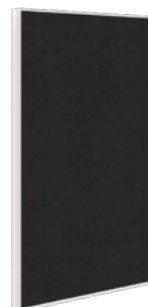

1890H x 1200L

## Fabric



1890H x 900L

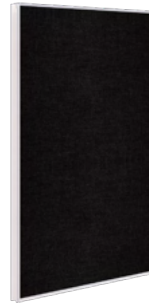

1890H x 1200L

## Whiteboard



1890H x 1200L

## Curved Fin



1890H x 625R 90°



1890H x 810R 90°



1890H x 1225R 45°

## Curved Fin Acoustic

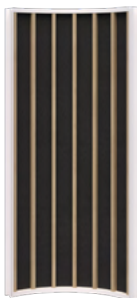

1890H x 625R 90°

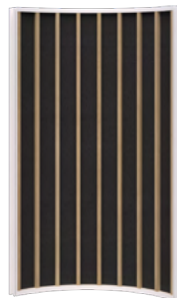

1890H x 810R 90°

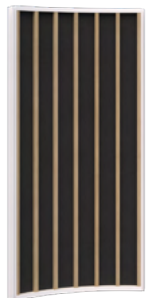

1890H x 1225R 45°

## Curved Fin Glazed



1890H x 625R 90°



1890H x 810R 90°



1890H x 1225R 45°

## Curved Fin Acoustic Glazed



1890H x 625R 90°



1890H x 810R 90°



1890H x 1225R 45°

## Premium Pots



Soft Round  
Anthracite



Soft Round  
Delicate Pink



Soft Round  
Leaf Green



Soft Round  
Soft White



Round  
Anthracite



Round Nude



Round Mint



Round Brown



Round White



Freestanding  
Foot



Focus Room  
Desktop

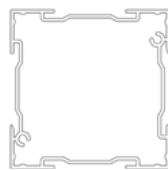

90 Degree  
Corner Post



End Cap

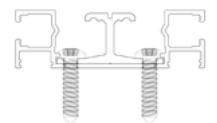

Wall Start

## SPECIFICATIONS:

- Powder coated aluminum frame, endcaps and feet
- Fins in 25mm Melamine
- 10mm Acoustic panels in-between fins (NRC 0.41)
- 4mm Annealed glass in-between fins on glazed screens
- Plant Wall is supplied with black 16cm pots, option to upgrade to premium pots
- Recyclable Frame
- 15 Year Warranty

# PLAN CONNECT

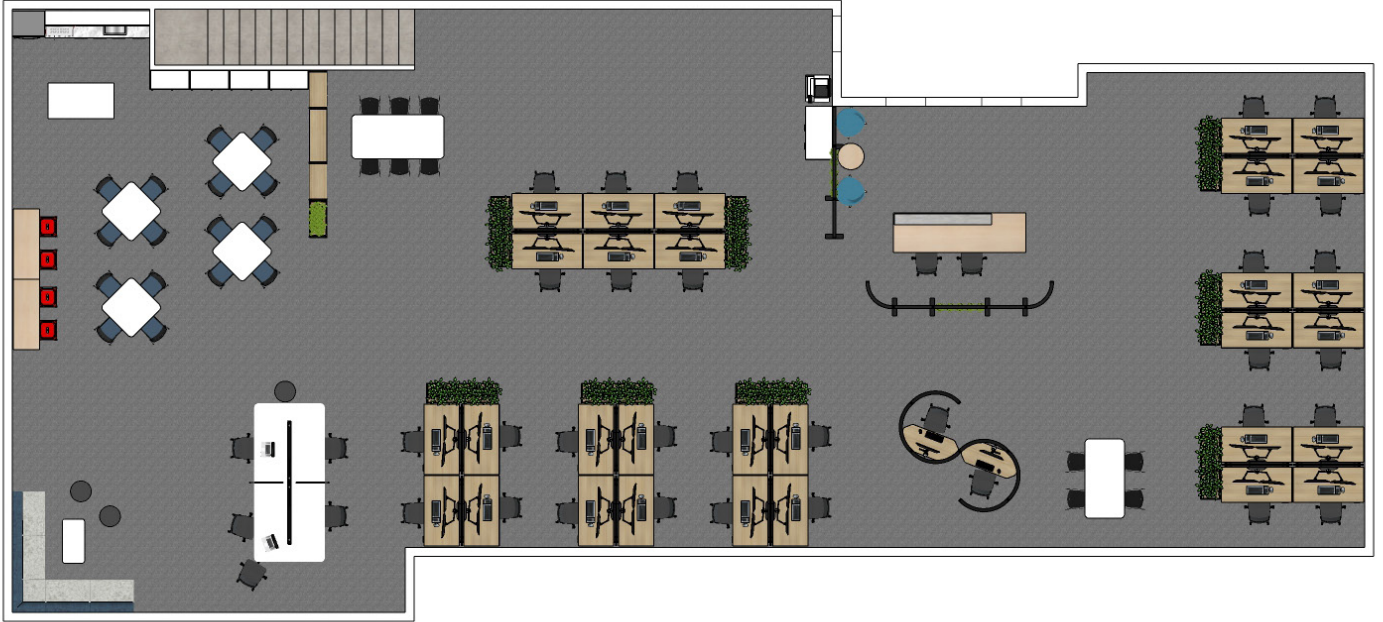

Connect works perfectly in a floor plan where the customer requires different zones or focus spaces. Accent will work with you to design a stunning customised look to present to your customers.

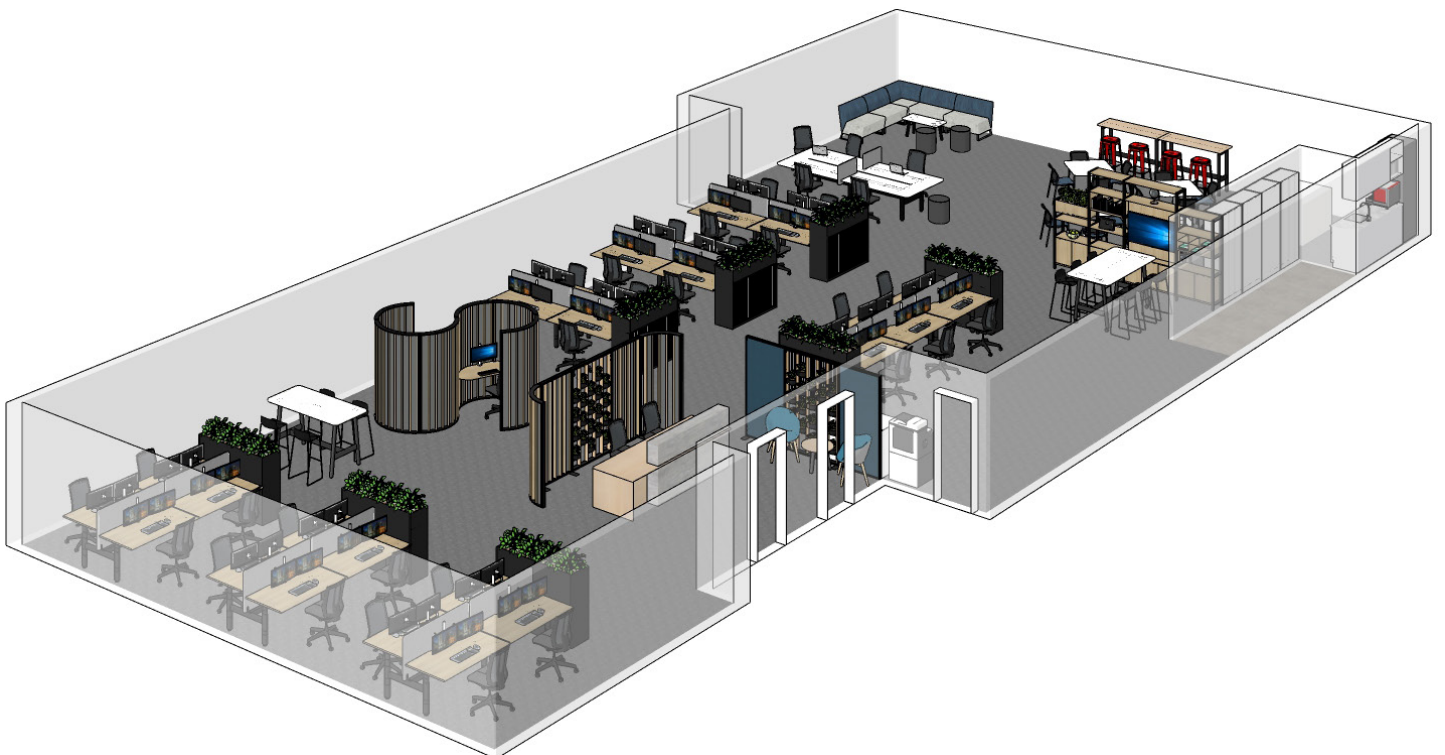



Connect also works perfectly in a floor plan where the customer wants to create private office spaces without building permanent walls. Using glazed modules to create rooms, which can be reconfigured if no longer required. Contact the team at Accent to start designing your custom fit-out now.

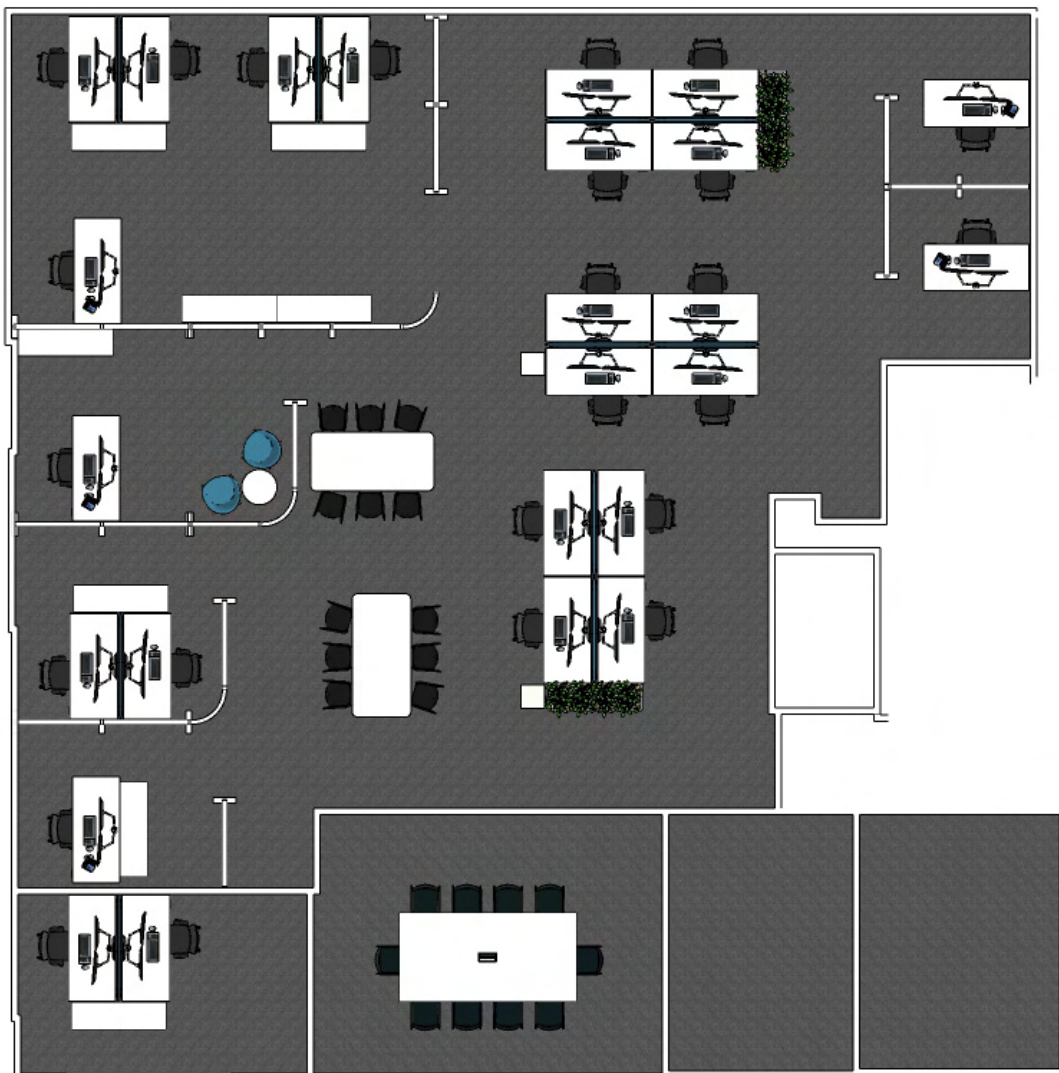

## Stock Finishes

---



Classic Oak  
*Naturale*



Refined Oak  
*Naturale*

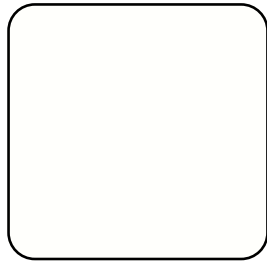

Snow  
*Velvet*

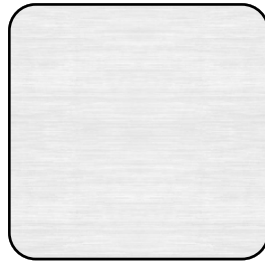

Silver Strata  
*Naturale*

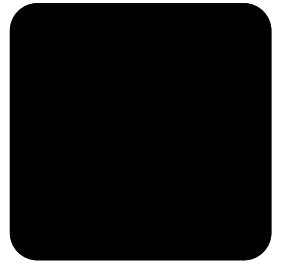

Black  
*Pearl*



Black  
*Powdercoat*



White  
*Powdercoat*

## Stock Fabrics Options

---



Keylargo Paprika

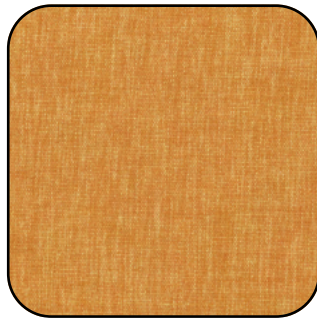

Keylargo Marigold



Keylargo Grass



Keylargo Atlantic



Keylargo Pumice



Keylargo Anthracite



Keylargo Ebony



Keylargo Denim

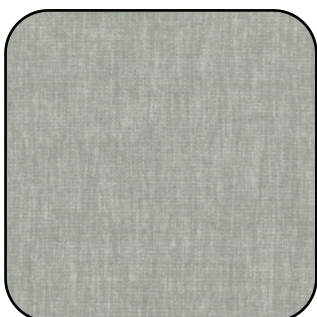

Keylargo Zinc

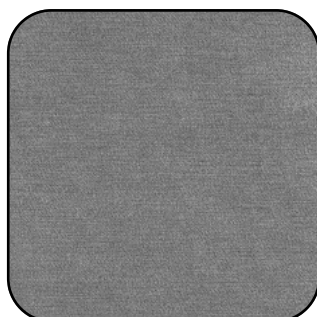

Fletcher Pebble

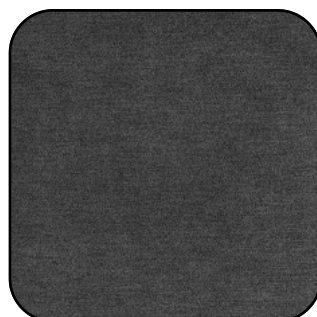

Fletcher Pepper

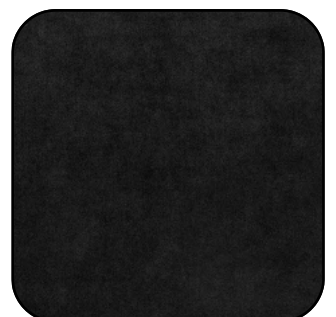

Fletcher Midnight

## Stock Acoustic Options

---



Black



Fawn

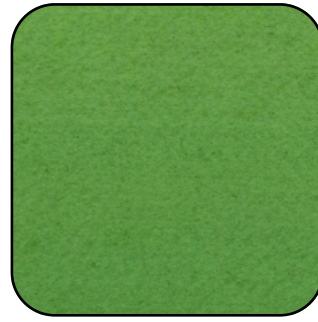

Bright Green



Green



White



Red

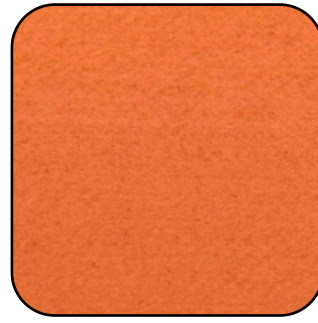

Orange



Yellow



Light Grey



Charcoal



Navy



Blue



CERTIFIED 'BUY NZ MADE'

Connect is just one of a wide range of our products that are certified 'Buy NZ Made'. By designing, sourcing and manufacturing products in New Zealand we can:

- Eliminate stockouts
- Reliably offer fast and flexible delivery timeframes
- Customize products to suit the unique needs of your customers
- Reduce carbon footprint
- And keep great Kiwis employed!



0800 378 953  
info@ergostyle.co.nz